

DK

DE

NO

SE

GB

NL

FI

FR

RU

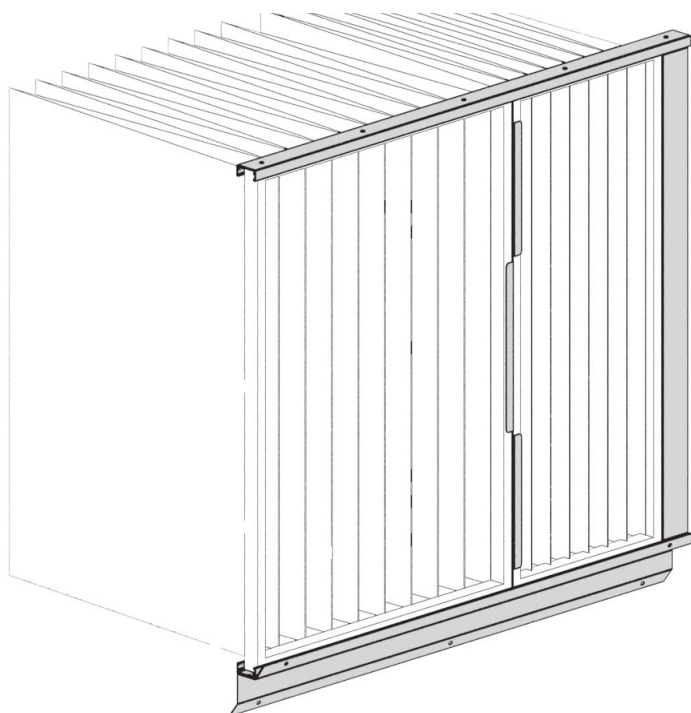

## **Retrofit Filter Kit VEX350/360**

<b>1. DK - Eftermontage af posefilter VEX350/360</b> .....	<b>3</b>
1.1 Afmontering af kompaktfiltre .....	3
1.2 Forberedelse for montering af posefiltre .....	4
1.3 Montering af posefiltre .....	5
<b>1. DE - Nachmontage von Taschenfilter VEX350/360</b> .....	<b>6</b>
1.1 Abmontieren von Kompaktfiltern .....	6
1.2 Vorbereitung für die Montage von Taschenfiltern .....	7
1.3 Montage von Taschenfiltern .....	8
<b>1. NO - Ettermontering av posefilter VEX350/360</b> .....	<b>9</b>
1.1 Utmontering av kompaktfiltre .....	9
1.2 Forberedelse for montering av posefiltre .....	10
1.3 Montering av posefiltre .....	11
<b>1. SE - Eftermontering av påsfilter VEX350/360</b> .....	<b>12</b>
1.1 Demontering av kompaktfiltre .....	12
1.2 Förberedelse för montering av påsfilter .....	13
1.3 Montering av påsfilter .....	14
<b>1. GB - Retrofitting bag filter VEX350/360</b> .....	<b>15</b>
1.1 Disassembly of compact filters .....	15
1.2 Preparations for mounting bag filters .....	16
1.3 Mounting the bag filters .....	17
<b>1. NL - Namonteren van zakfilter VEX350/360</b> .....	<b>18</b>
1.1 Afmonteren van compactfilters .....	18
1.2 Voorbereiden van zakfiltermontage .....	19
1.3 Monteren van zakfilters .....	20
<b>1. FI - VEX350/360-pussisuodattimen jälkiasennus</b> .....	<b>21</b>
1.1 Pienikokoisen suodattimen irrottaminen .....	21
1.2 Valmistelut pussisuodattimen asennusta varten .....	22
1.3 Pussisuodattimen asentaminen .....	23
<b>1. FR - Montage a posteriori du filtre à poches VEX350/360</b> .....	<b>24</b>
1.1 Démontage des filtres compacts .....	24
1.2 Préparation pour le montage des filtres à poches .....	25
1.3 Montage des filtres à poches .....	26
<b>1. RU - Последующая установка мешочного фильтра VEX350/360</b> .....	<b>27</b>
1.1 Демонтаж компактных фильтров .....	27
1.2 Подготовка к установке мешочных фильтров .....	28
1.3 Установка мешочных фильтров .....	29

## 1. DK - Eftermontage af posefilter VEX350/360

Følgende dele medleveres:

Aluprofil	4 stk
Styr for aluprofil	2 stk
Afstandsstykke	2 stk
Støtteplade	2 stk
Undersænket popnitte $\varnothing 4$	20 stk
Popnitte $\varnothing 4,8$	14 stk
Tætningsliste	1,2 m

### Bemærk!

Posefiltrene skal bestilles separat.



**Afbryd strømmen på forsyningsadskilleren før lågen åbnes.**

Placering af filtrene varierer afhængig af placering af ventilatorer/luftretning. Billederne viser et VEX360-aggregat med ventilatorplacering LEFT.

### 1.1 Afmontering af kompaktfiltre

Trin	Handling	Billede
1.	Træk filtrene ud.  NB! Udskiftede filtre bør straks lægges i en plastpose, som lukkes tæt og bortskaffes på forsvarlig vis.	
2.	Fjern skinnerne som holder kompaktfiltrene. De 2 x 3 popnitter bores ud med bor-størrelse $\varnothing 4$ .	

## 1.2 Forberedelse for montering af posefiltre

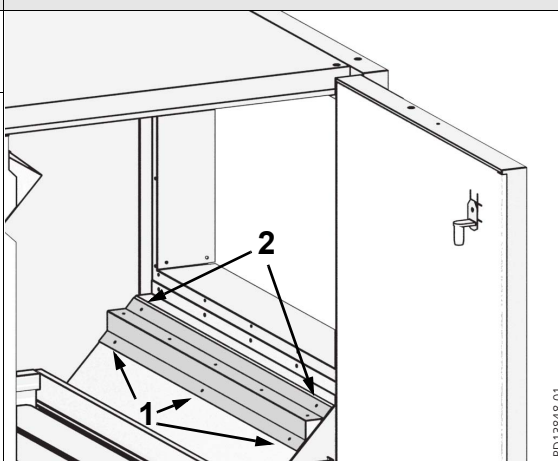
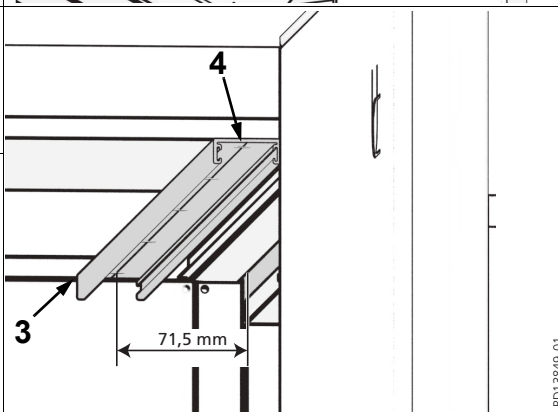
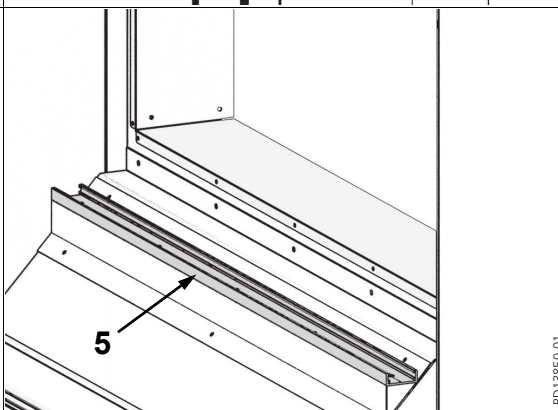
Trin	Handling	Billede
1.	Monter styr for aluprofil med popnitter i de tre udborede huller.	
2.	Bor ø5 huller gennem styrets 2 andre huller. Monter med popnitter.	
3.	Placering af aluprofil: Skub profilet helt ind mod bagvæggen. Afstand fra kabinetkant til center af huller skal være 71,5 mm.	
4.	Bor ø5 huller gennem profilets 5 huller. Monter profilet med undersænkede popnitter.	
5.	Monter profilet på styret med undersænkede popnitter.	

RD13848-01

RD13849-01

RD13850-01

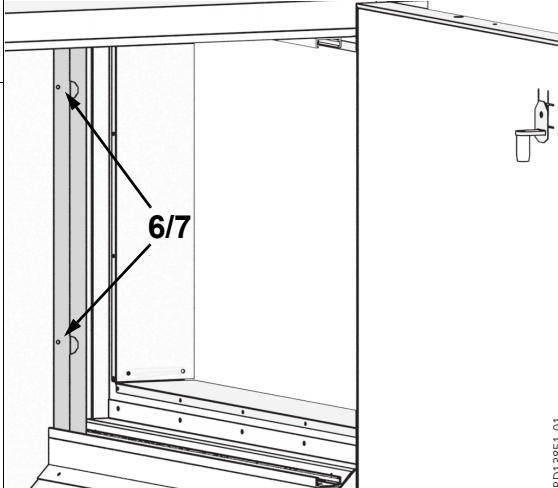
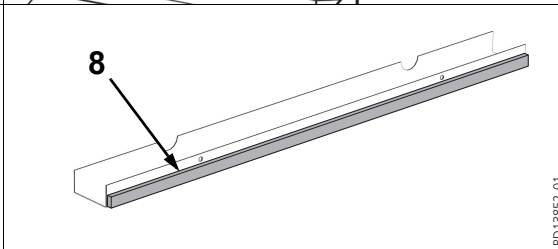
Trin	Handling	Billede
6.	Sæt afstandsstykket ind i aluprofilerne op mod bagvæggen.	
7.	Bor $\varnothing 5$ huller gennem afstandsstykkets huller.	
8.	Sæt klæbebånd på afstandsstykket og monter det på bagvæggen med popnitter.  NB! Vær opmærksom på at afstandsstykket vender korrekt som vist på tegning 6/7.	

### 1.3 Montering af posefiltre

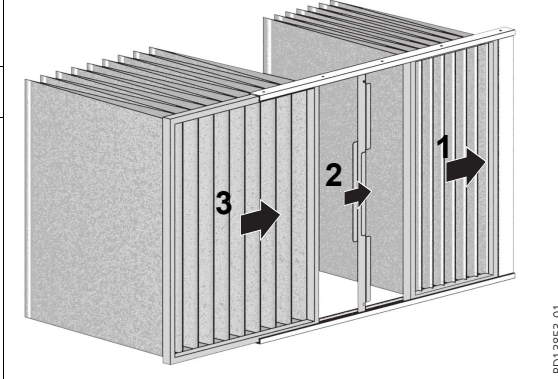
Trin	Handling	Billede
1.	Skub det mindste filter ind i profilerne op mod afstandsstykket.	
2.	Placer støttepladen.	
3.	Skub det største filter ind.	

For mere information vedrørende filterskift, se vejledningen for VEX-aggregatet.

# 1. DE - Nachmontage von Taschenfilter VEX350/360

Folgende Bauteile werden mitgeliefert:

Aluprofil	4 Stck.
Führung für Aluprofil	2 Stck.
Distanzstück	2 Stck.
Stützplatte	2 Stck.
Versenklblindniete $\varnothing 4$	20 Stck.
Blindniete $\varnothing 4,8$	14 Stck.
Dichtleiste	1,2 m

## Hinweis!

Taschenfilter müssen gesondert bestellt werden.



**Die Wartungstür erst nach Abschalten der Spannung an der Versorgungstrennung öffnen.**

Die Positionierung der Filter ist von der Anordnung der Ventilatoren/Luftrichtung abhängig. Die Abbildungen zeigen ein VEX360-Gerät mit Ventilatoranordnung LINKS.

## 1.1 Abmontieren von Kompaktfiltern

Schritt	Vorgehen	Abbildung
1.	Die Filter herausziehen  Hinweis! Ausgetauschte Filter sollten sofort in einen Kunststoffbeutel gelegt werden, der dicht zu verschließen und sorgfältig zu entsorgen ist.	
2.	Die Montageschienen der Kompaktfilter entfernen. Die 2 x 3 Blindnieten mit einem $\varnothing 4$ -Bohrer ausbohren.	

RD13847-01

## 1.2 Vorbereitung für die Montage von Taschenfiltern

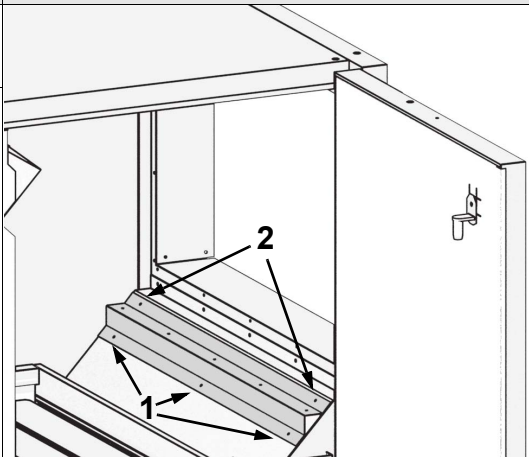
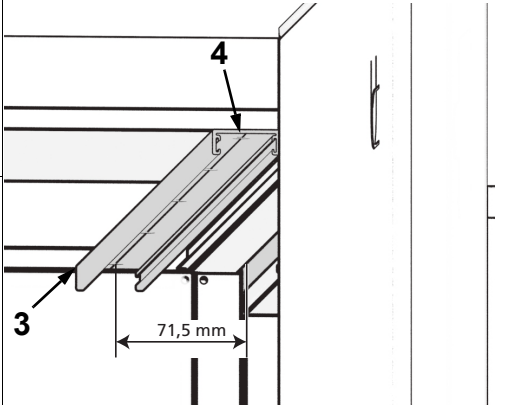
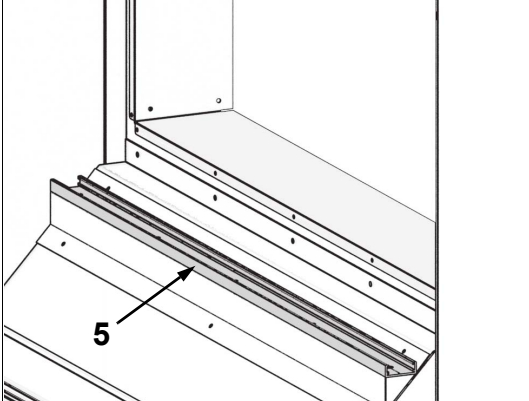
Schritt	Vorgehen	Abbildung
1.	Die Führung für das Aluprofil mit Blindnieten in den drei vorgebohrten Löchern montieren.	
2.	Zwei ø5-Löcher durch die beiden bereits vorhandenen Löcher in der Führung bohren. Mit Blindnieten montieren.	
3.	Positionierung des Aluprofils: Das Profil ganz in Richtung Rückwand drücken. Der Abstand vom Gehäuserand bis zur Mitte der Bohrungen muss 71,5 mm betragen.	
4.	ø5-Löcher durch die fünf bereits vorhandenen Löcher in der Führung bohren. Das Profil mit versenkten Blindnieten montieren.	
5.	Die Führung mit versenkten Blindnieten montieren.	

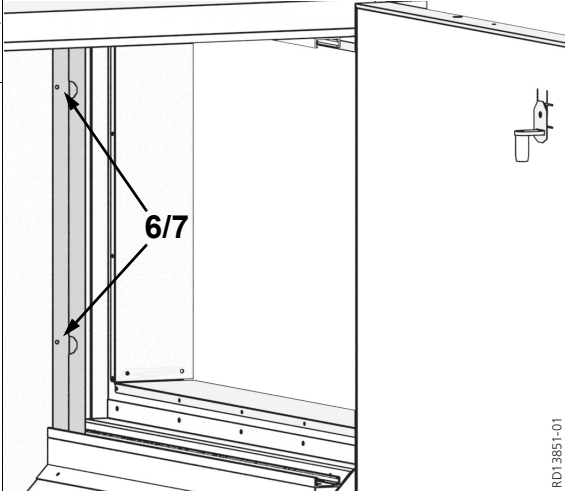
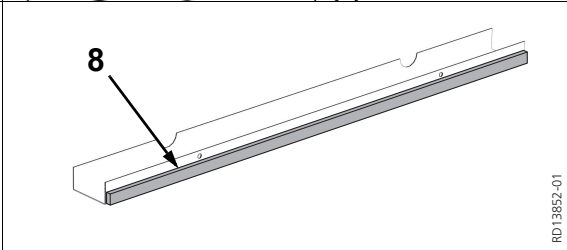
Schritt	Vorgehen	Abbildung
6.	Das Distanzstück in die Aluprofile an der Rückwand montieren.	
7.	ø5 Löcher durch die Löcher des Distanzstücks bohren.	
8.	<p>Klebeband am Distanzstück anbringen und danach das Distanzstück mit Blindnieten an der Rückwand montieren.</p> <p>Hinweis! Auf korrekte Orientierung des Distanzstücks achten, wie auf Abbildung 6/7 dargestellt.</p>	

RD13851-01

RD13852-01

### 1.3 Montage von Taschenfiltern

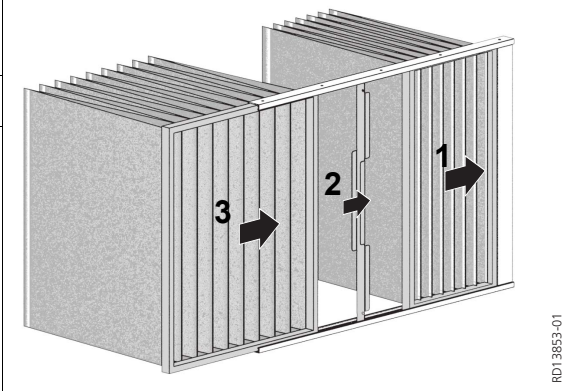
Schritt	Vorgehen	Abbildung
1.	Den kleinsten Filter in die Profile und in Richtung des Distanzstücks schieben.	
2.		
3.	Den größten Filter einschieben.	

RD13853-01

Für zusätzliche Information über Filtertausch siehe bitte die Anleitung des VEX-Geräts.



## 1. NO - Ettermontering av posefilter VEX350/360

Følgende deler medleveres:

Aluminiumsprofil	4
Styreskinne for aluminiumsprofil	2
Avstandsstykke	2
Støtteplate	2
Forsenket popnagle Ø4 mm	20
Popnagle Ø4,8 mm	14
Tetningslist	1,2 m

### Merk!

Posefiltre må bestilles separat.



Slå av strømmen på skillebryteren før luken åpnes.

Filtrenes plassering avhenger av viftenes plassering/luftretningen. Bildene viser et VEX360-aggregat med vifteplassering LEFT.

### 1.1 Utmontering av kompaktfiltre

Trinn	Handling	Bilde
1.	Trekk ut filtrene.  NB! Filtre som er byttet ut, bør straks legges i en plastpose, som lukkes tett og destrueres på forsvarlig måte.	
2.	Fjern skinnene som holder kompaktfiltrene. Bor ut de 2 x 3 popnaglene med et Ø4 mm bor.	

RD13847-01

## 1.2 Forberedelse for montering av posefiltere

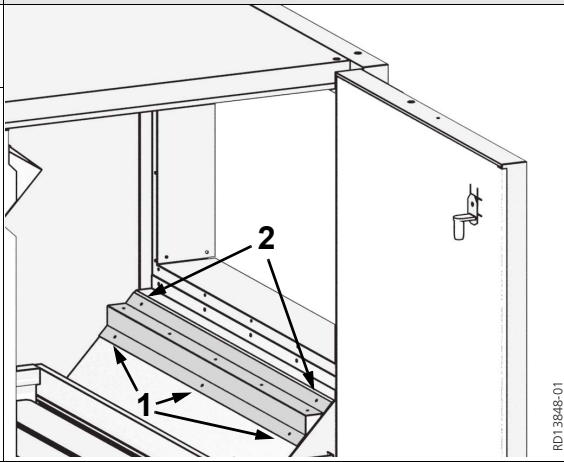
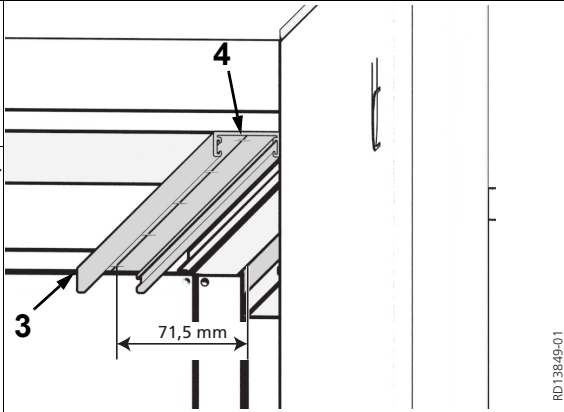
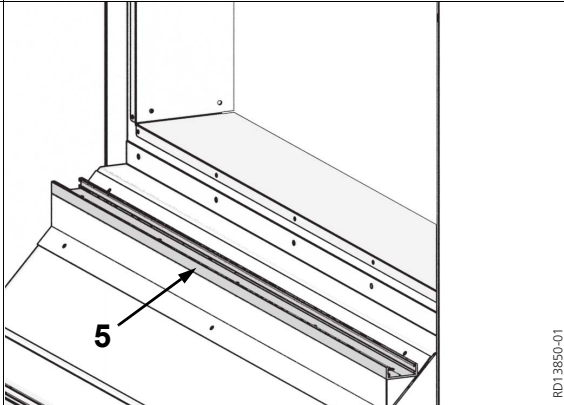
Trinn	Handling	Bilde
1.	Monter styreskinnen for aluminiumsprofilen med popnagler i de tre utborede hullene.	
2.	Bor Ø5 mm hull gjennom de to andre hullene på styreskinnen. Monter styreskinnen med popnagler.	
3.	Sett inn aluminiumsprofilen: Skyv profilen helt inn mot bakveggen. Avstanden fra kabinettkanten til sentrum av hullene skal være 71,5 mm.	
4.	Bor Ø5 mm hull gjennom de 5 hullene på profilen. Monter profilen med forsenkede popnagler.	
5.	Monter profilen på styreskinnen med forsenkede popnagler.	

RD13848-01

RD13849-01

RD13850-01

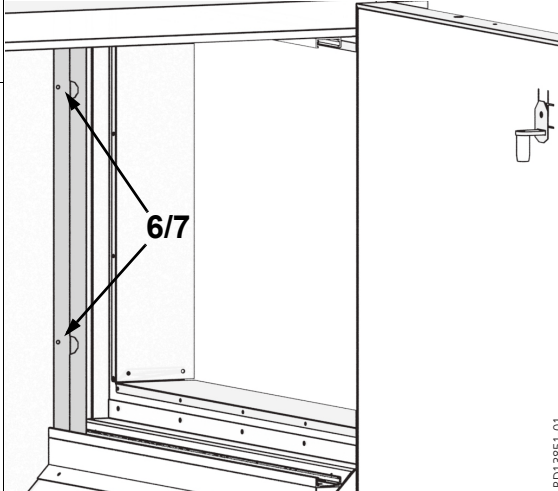
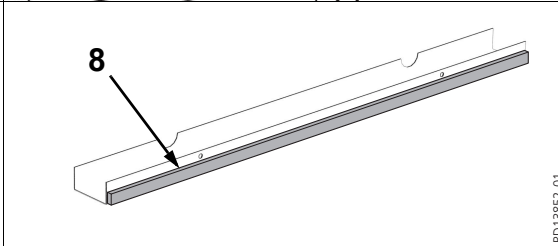
Trinn	Handling	Bilde
6.	Sett avstandsstykket inn i aluminiumsskinnen og opp mot bakveggen.	
7.	Bor Ø5 mm hull gjennom hullene på avstandsstykket.	
8.	Sett klebebånd på avstandsstykket og monter det på bakveggen med popnagler.  <b>NB!</b> Sørg for at avstandsstykket vender riktig vei som vist på tegning 6/7.	

### 1.3 Montering av posefiltre

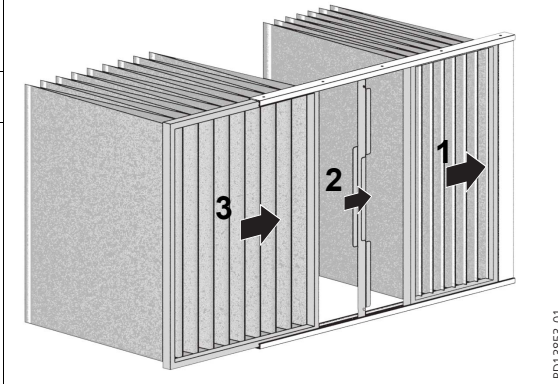
Trinn	Handling	Bilde
1.	Skyv det minste filteret inn i profilene og opp mot avstandsstykket.	
2.	Sett inn støtteplaten.	
3.	Skyv inn det største filteret.	

Du finner mer informasjon om filterskift i veiledningen for VEX-aggregatet.

## 1. SE - Eftermontering av påsfilter VEX350/360

Följande delar medföljer:

Aluminiumprofil	4 st.
Guide för aluminiumprofil	2 st.
Distans	2 st.
Stödplatta	2 st.
Försänkta popnitar $\varnothing 4$	20 st.
Popnitar $\varnothing 4,8$	14 st.
Tätninglist	1,2 m

**Observera!** Påsfiltren ska beställas separat.



**Bryt strömmen med huvudströmbrytaren innan luckan öppnas.**

Filtrens placering är beroende av fläktarnas placering/luftriktning. Bilderna visar ett VEX360-aggregat med fläktplacering LEFT.

### 1.1 Demontering av kompaktfiltren

Steg	Åtgärd	Bild
1.	Dra ut filtren.  OBS! Utbytta filter bör genast läggas i en plastpåse som tillsluts och avfallshanteras på föreskrivet sätt.	
2.	Ta bort skenorna som håller kompaktfiltren. Borra ut popnitarna (2 x 3) med borrstorlek $\varnothing 4$ .	

RD13847-01

## 1.2 Förberedelse för montering av påsfilter

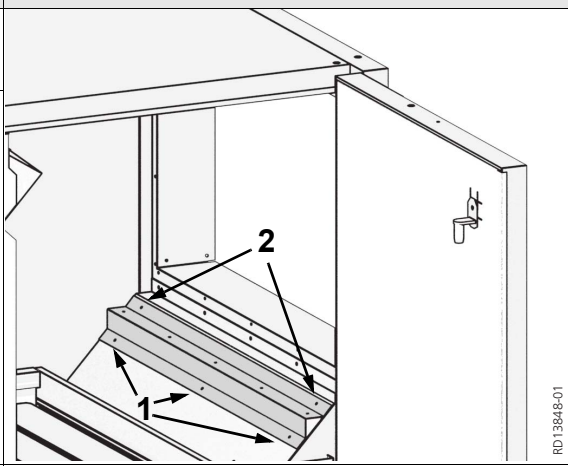
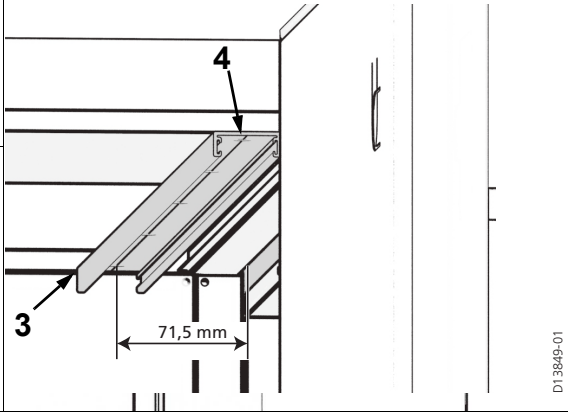
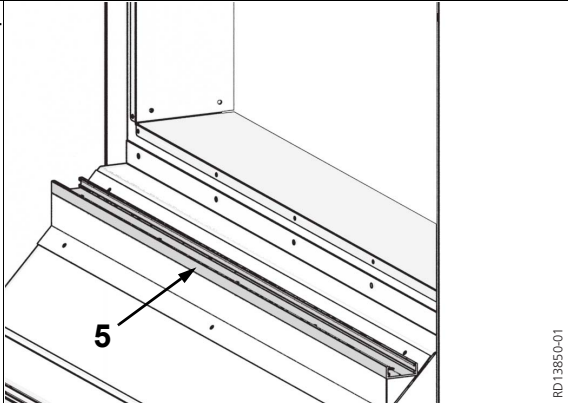
Steg	Åtgärd	Bild
1.	Montera guide för aluminiumprofil med popnitar i de tre utborrade hålen.	
2.	Borra hål med $\varnothing 5$ genom guidens två övriga hål. Montera med popnitar.	
3.	Placering av aluminiumprofil: Skjut in profilen helt mot den bakre väggen. Avstånd från skåpets kant till hålens centrum ska vara 71,5 mm.	
4.	Borra hål med $\varnothing 5$ genom profilens fem hål. Montera profilen med försänkta popnitar.	
5.	Montera profilen på guiden med försänkta popnitar.	

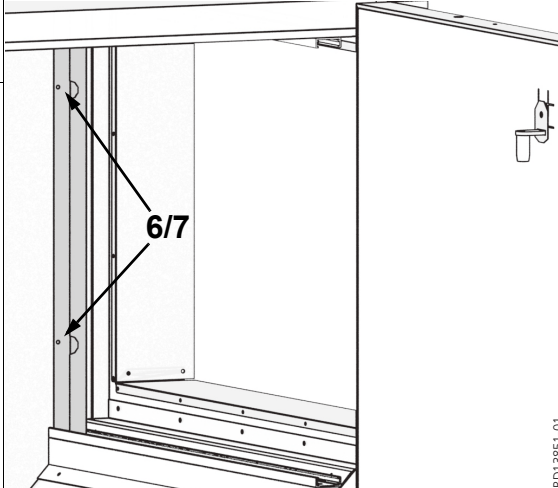
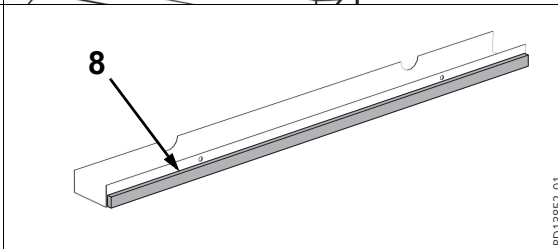
Steg	Åtgärd	Bild
6.	Sätt i distansen i aluminiumprofilerna mot den bakre väggen.	
7.	Borra hål med $\varnothing 5$ genom distansens hål.	
8.	Sätt fast tejp på distansen och montera den på den bakre väggen med popnitar.  OBS! Kontrollera att distansen är korrekt vänd, som bild 6/7 visar.	

### 1.3 Montering av påfilter

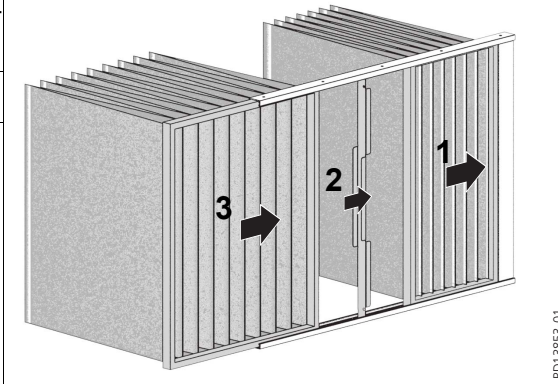
Steg	Åtgärd	Bild
1.	Skjut in det minsta filtret i profilerna mot distansen.	
2.	Placera stödplattan.	
3.	Skjut in det största filtret.	

För mer information angående filterbyte, se handboken för VEX-aggregatet.

# 1. GB - Retrofitting bag filter VEX350/360

The following parts are included:

Aluminium profile	4 items
Guide for aluminium profile	2 items
Spacer	2 items
Support plate	2 items
Countersunk pop rivet, 4 mm	20 items
Pop rivet, 4.8 mm	14 items
Sealing strip	1.2 m

**Please note!** Bag filters must be ordered separately.



**Disconnect power at the isolation switch before opening the door.**

Location of filters will depend on location of fans/air direction. The photographs shows a VEX360 unit with LEFT fan location.

## 1.1 Disassembly of compact filters

Step	Action	Photo
1.	<p>Pull the filters out.</p> <p>NB Discarded filters must be stored immediately in sealed plastic bags and disposed of responsibly.</p>	
2.	<p>Remove the rails holding the compact filters. Drill out the 2x3 pop rivets with a 4 mm drill bit.</p>	

RD13847-01

## 1.2 Preparations for mounting bag filters

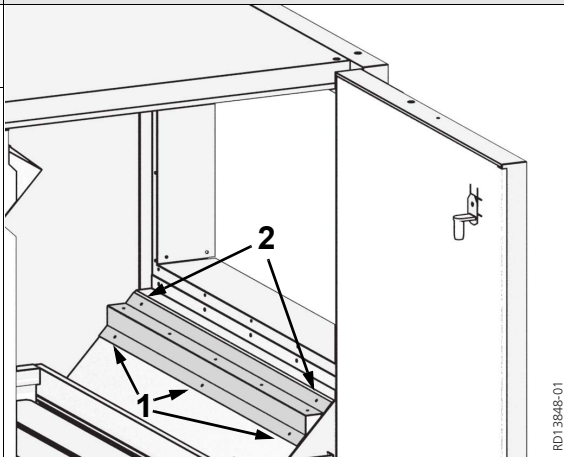
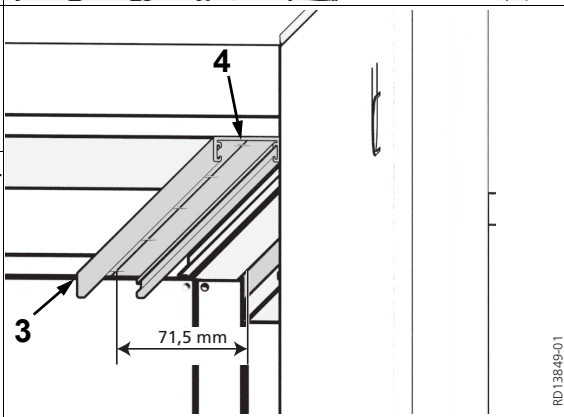
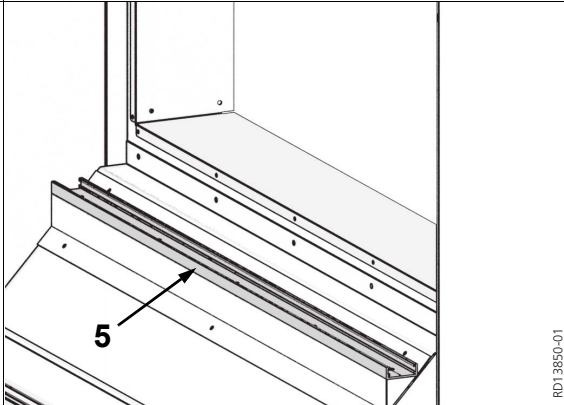
Step	Action	Photo
1.	Mount the guide for the aluminium profile with pop rivets in the three drilled-out holes.	
2.	Drill 5 mm holes through the other 2 holes in the guide. Mount with pop rivets.	
3.	Placement of aluminium profile: Insert the profile all the way to the rear wall. The distance from the cabinet edge to the hole centres must be 71.5 mm.	
4.	Drill 5 mm holes through the 5 holes in the profile. Mount the profile with countersunk pop rivets.	
5.	Mount the profile on the guide with countersunk pop rivets.	

RD13848-01

RD13849-01

RD13850-01

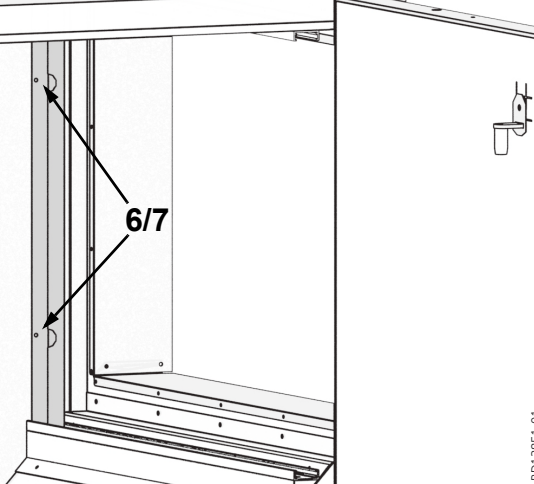
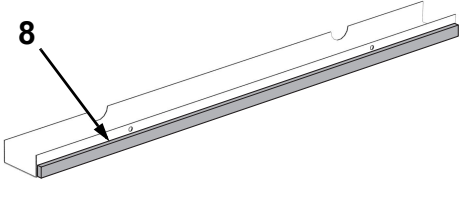

Step	Action	Photo
6.	Place the spacer on the aluminium profiles against the rear wall.	
7.	Drill 5 mm holes through the holes in the spacer.	
8.	<p>Apply adhesive tape to the spacer and mount it on the back wall with pop rivets.</p> <p>NB Make sure the spacer is facing the right way, as shown on drawing 6/7.</p>	

RD13851-01

RD13852-01

### 1.3 Mounting the bag filters

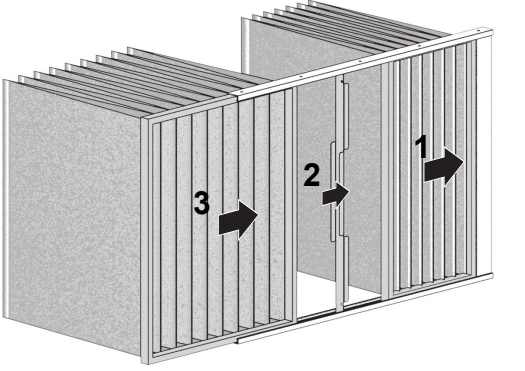
Step	Action	Photo
1.	Push the smaller filter onto the profiles and against the spacer.	
2.	Position the support plate.	
3.	Insert the larger filter.	

RD13853-01

For more information on changing filters, see the VEX unit instructions.

## 1. NL - Namonteren van zakfilter VEX350/360

De volgende onderdelen zijn inbegrepen in de levering:

Aluminium profiel	4 st.
Geleiding voor aluminium profiel	2 st.
Afstandsstuk	2 st.
Steunplaat	2 st.
Verzonken klinknagels	20 st.
Klinknagels $\varnothing 4,8$	14 st.
Afdichtprofiel	1,2 m

**Opgelet:** De zakfilters moeten afzonderlijk worden besteld.



**Onderbreek de stroom met de werkschakelaar voordat u de deur opent.**

De plaatsing van de filters varieert en is afhankelijk van de plaatsing van de ventilatoren en de luchtrichting. De afbeeldingen tonen een VEX360-unit met ventilatorplaatsing LEFT.

### 1.1 Afmonteren van compactfilters

Stap	Actie	Afbeeldingen
1.	Trek de filters naar buiten.  Opgelet! Plaats de oude filters meteen in een plastic zak, sluit de zak af en deponeer deze op verantwoorde wijze.	
2.	Verwijder de rails die de compactfilters op hun plaats houden. Boor de 2 x 3 klinknagels uit met boorgrootte $\varnothing 4$ .	

RD13847-01

## 1.2 Voorbereiden van zakfiltermontage

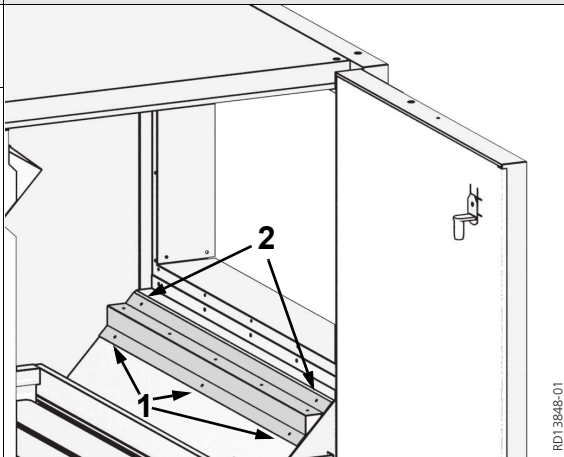
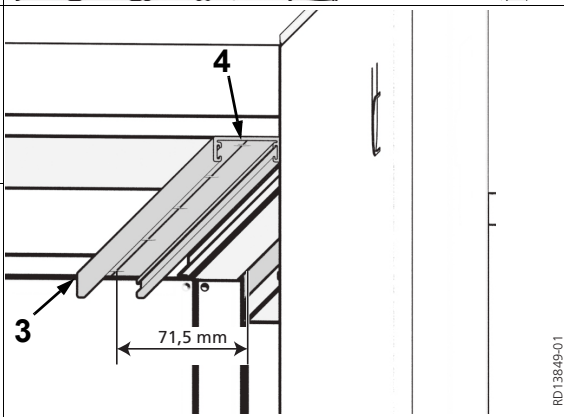
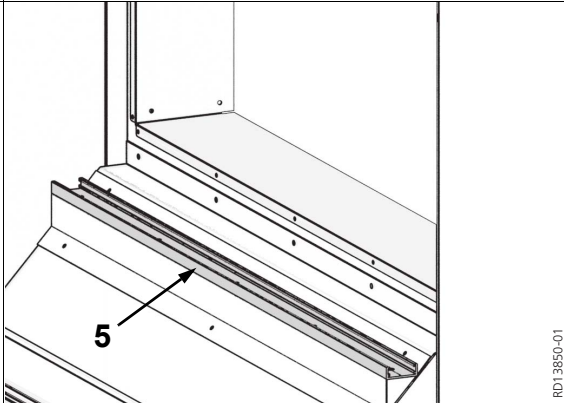
Stap	Actie	Afbeeldingen
1.	Monteer de geleiding voor het aluminium profiel in de drie geboorde gaten.	
2.	Boor $\varnothing 5$ -gaten door de 2 andere gaten in de geleiding. Monteer met klinknagels.	
3.	Plaatsing van aluminium profiel: Schuif het profiel helemaal in tegen de achterwand. De afstand van de rand van de kast tot aan het hart van de gaten moet 71,5 mm zijn.	
4.	Boor $\varnothing 5$ -gaten door de 5 gaten in het profiel. Monteer het profiel met verzonken klinknagels.	
5.	Monteer het profiel op de geleiding met verzonken klinknagels.	

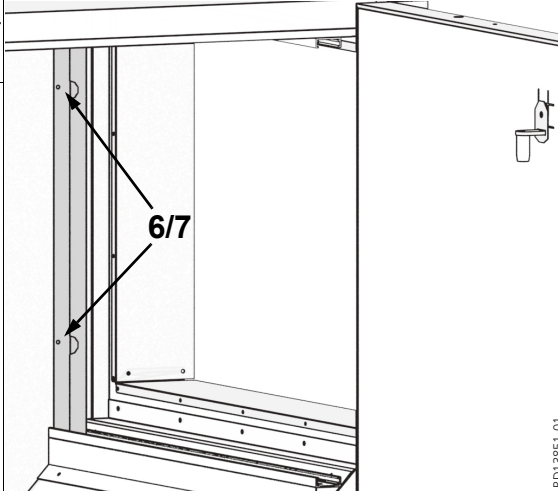
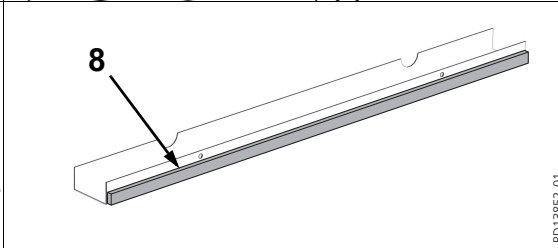
Stap	Actie	Afbeeldingen
6.	Plaats het afstandsstuk in de aluminium profielen tegen de achterwand.	
7.	Boor $\varnothing 5$ -gaten door de gaten in het afstandsstuk.	
8.	Breng kleefband aan op het afstandsstuk en monteer het op de achterwand met klinknagels.  Opgelet! Zorg ervoor dat het afstandsstuk correct geplaatst is, zoals getoond in tekening 6/7.	

### 1.3 Monteren van zakfilters

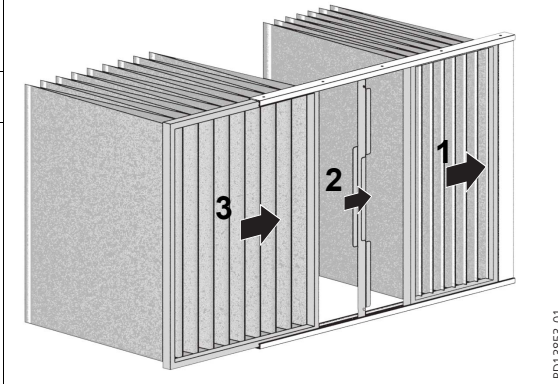
Stap	Actie	Afbeeldingen
1.	Schuif het kleinste filter in de profielen tegen het afstandsstuk.	
2.	Plaats de steunplaat.	
3.	Schuif het grootste filter in positie.	

Zie voor meer informatie over het vervangen van filters de handleiding van de VEX-unit.

## 1. FI - VEX350/360-pussisuodattimen jälkiasennus

Toimitus sisältää seuraavat osat:

Alumiiniprofiili	4 kpl
Alumiiniprofiilin ohjain	2 kpl
Välikappale	2 kpl
Tukilevy	2 kpl
Uppokantainen pop-niitti $\varnothing$ 4	20 kpl
Pop-niitti $\varnothing$ 4,8	14 kpl
Tiivistyslista	1,2 m

### Huomaa!

Pussisuodattimet on tilattava erikseen.



**Katkaise virta huoltokytkimestä ennen luukkujen avaamista.**

Suodattimien sijainti määräytyy puhaltimien / ilman suunnan mukaan. Kuvissa näkyy VEX360-kone, jonka puhaltimen sijainti on LEFT.

### 1.1 Pienikokoisen suodattimen irrottaminen

Vaihe	Käsittely	Kuvat
1.	Vedä suodattimet ulos.  HUOMIO! Vaihdetut suodattimet on laitettava heti muovipussiin ja hävitettävä jätehuoltomääräysten mukaisesti.	
2.	Irrota kiskot, jotka pitävät pienikokoisia suodattimia paikoillaan. 2 x 3 -pop-niitit porataan ulos $\varnothing$ 4 -kokoisella poranterällä.	

## 1.2 Valmistelut pussisuodattimen asennusta varten

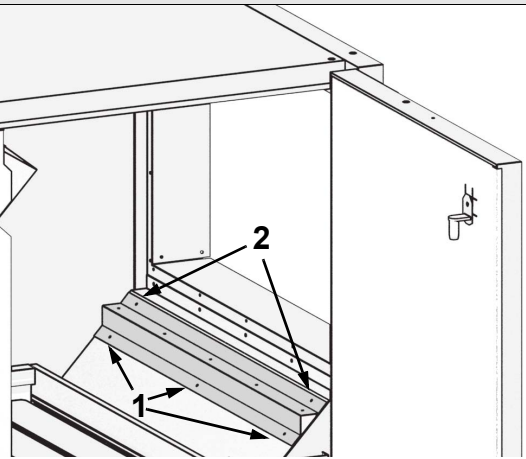
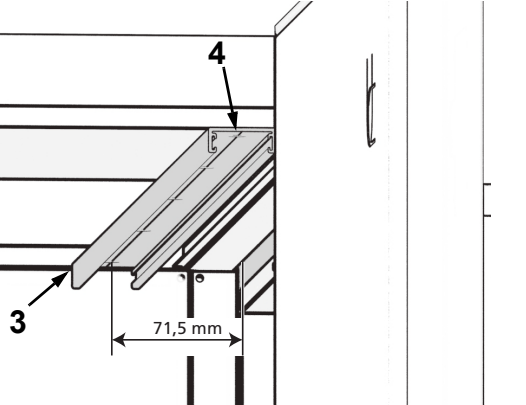
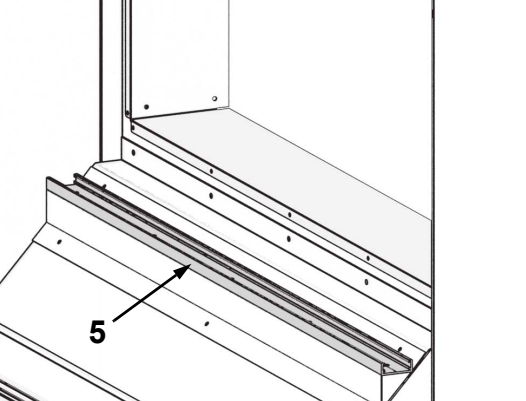
Vaihe	Käsittely	Kuvat
1.	Asenna alumiiniprofiilin ohjain pop-niiteillä kolmeen porattuun aukkoon.	
2.	Poraa $\varnothing 5$ -reiät ohjaimen 2 reiän läpi. Asenna pop-niiteillä.	
3.	Alumiiniprofiilin sijainti: Työnnä profiili kokonaan takaseinämän sisään. Etäisyyden kaapin reunasta aukkojen keski-kohtaan tulee olla 71,5 mm.	
4.	Poraa $\varnothing 5$ -reiät profiiliin 5 reiän läpi. Asenna profiili uppokantaisilla pop-niiteillä.	
5.	Asenna profiili ohjaimeen uppokantaisilla pop-niiteillä.	

RD13848-01

RD13849-01

RD13850-01

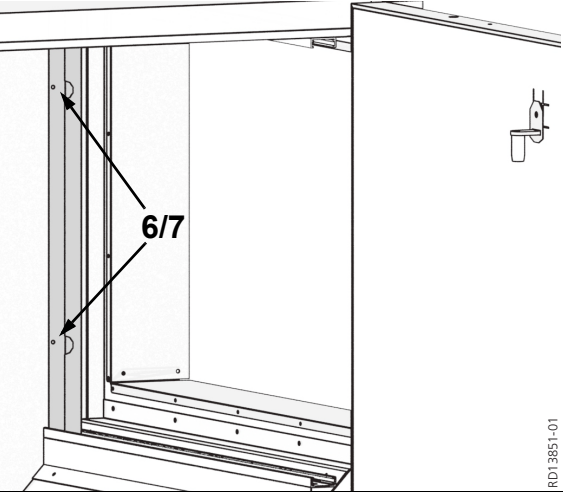
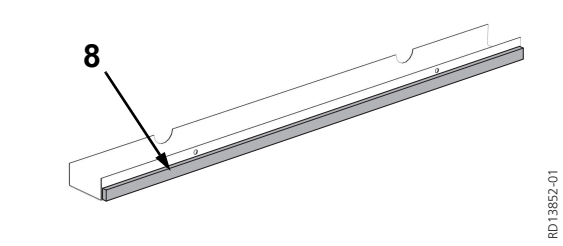
Vaihe	Käsittely	Kuvat
6.	Aseta takaseinään kiinnitettävien alumiiniprofiilien alle välikappale.	
7.	Poraa $\varnothing 5$ -reiät välikappaleen aukkojen läpi.	
8.	Aseta välikappaleen päälle tarranauhaa. Asenna se takaseinään pop-niiteillä.  HUOMIO! Huolehdi, että välikappale kääntyy oikein piirroksessa 6/7 näkyvällä tavalla.	

### 1.3 Pussisuodattimen asentaminen

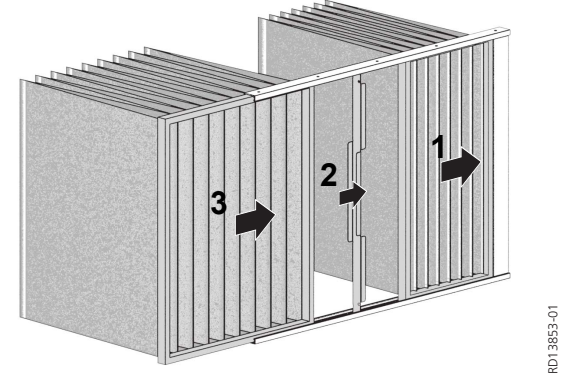
Vaihe	Käsittely	Kuvat
1.	Työnnä pienin suodatin profiileihin välikappaletta vasten.	
2.	Aseta tukilevy paikalleen.	
3.	Työnnä ensimmäinen suodatin sisään.	

VEX-laitteen ohjekirjassa on lisätietoja suodattimien vaihtamisesta.

## 1. FR - Montage a posteriori du filtre à poches VEX350/360

Les pièces suivantes sont fournies avec le kit :

Profil aluminium	4 unités
Guides de profil aluminium	2 unités
Entretoises	2 unités
Plaque de support	2 unités
Rivets pop noyés $\varnothing$ 4	20 unités
Rivets pop $\varnothing$ 4,8	14 unités
Joints	1,2 m

**Remarque :** Les filtres à poches doivent être commandés séparément.



**Avant d'ouvrir la porte, mettre le dispositif hors tension à l'aide de l'interrupteur d'alimentation.**

Le positionnement des filtres diffère en fonction de la position des ventilateurs/du sens de circulation de l'air. Les illustrations montrent un appareil VEX360 dont le ventilateur est placé à GAUCHE

### 1.1 Démontage des filtres compacts

Étape	Opération	Illustration
1.	Retirez les filtres.  NOTER ! Placer immédiatement les filtres retirés dans un sac en plastique, le fermer hermétiquement et l'éliminer de manière responsable.	
2.	Retirez les guides maintenant les filtres compacts. Percez les 2 x 3 rivets pop à l'aide d'un foret $\varnothing$ 4.	

RD13847-01

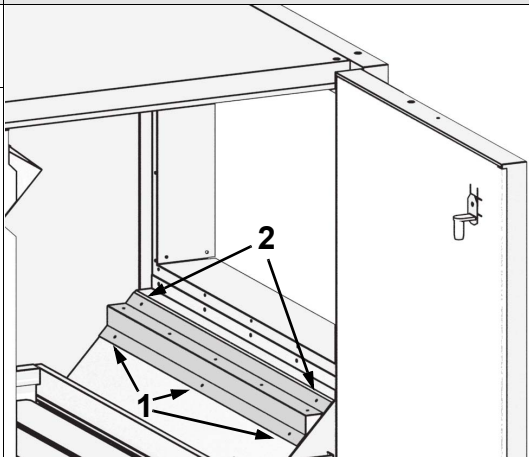
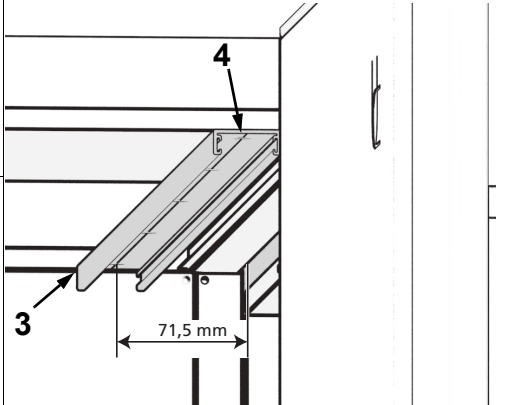
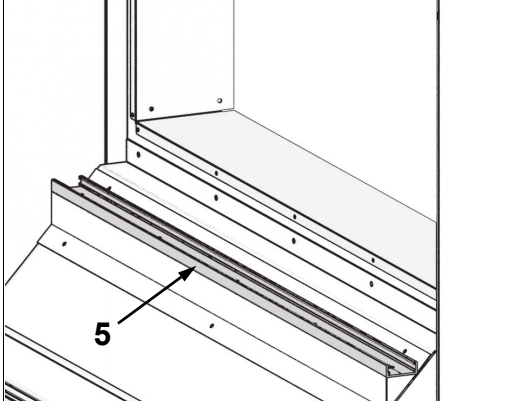

## 1.2 Préparation pour le montage des filtres à poches

Étape	Opération	Illustration
1.	Montez le guide pour le profil aluminium à l'aide de rivets pop sur les trois trous percés.	
2.	Percez des trous $\varnothing 5$ à travers les deux autres trous du guide. Montez à l'aide de rivets pop.	
3.	Emplacement du profil aluminium : Poussez le profil à fond, jusqu'à la paroi arrière. La distance entre le bord du caisson et l'axe des trous doit être de 71,5 mm.	
4.	Percez des trous $\varnothing 5$ à travers les 5 trous du profil. Montez le profil à l'aide de rivets pop noyés.	
5.	Montez le profil sur le guide à l'aide de rivets pop noyés.	

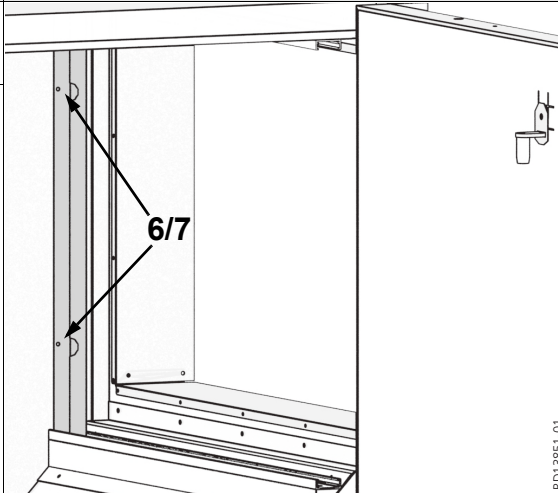
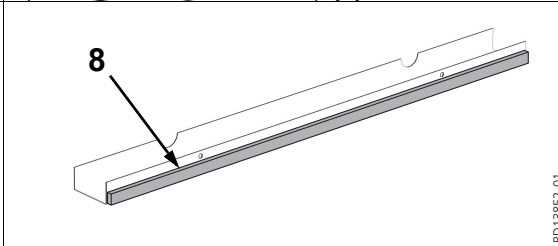
Étape	Opération	Illustration
6.	Placez l'entretoise à l'intérieur du profil aluminium contre la paroi arrière.	
7.	Percez des trous $\varnothing 5$ à travers les trous de l'entretoise.	
8.	Placez la bande adhésive sur l'entretoise et montez-la sur la paroi arrière à l'aide rivets pop.  NOTER ! Assurez-vous que l'entretoise est tournée dans le bon sens comme indiqué sur le schéma 6/7.	

### 1.3 Montage des filtres à poches

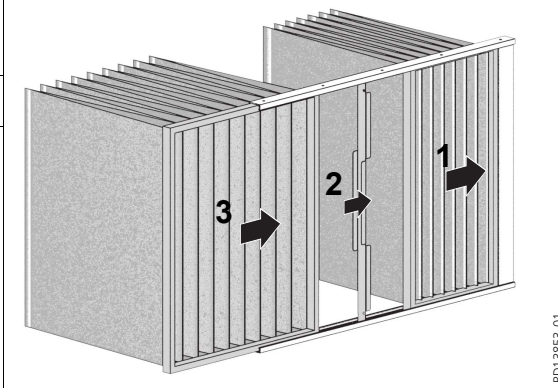
Étape	Opération	Illustration
1.	Faites glisser le plus petit des filtres sur les profils, jusqu'à l'entretoise.	
2.	Placez la plaque de support.	
3.	Poussez le plus grand filtre en place.	

Pour plus d'informations concernant le remplacement des filtres, veuillez consulter le manuel de l'appareil VEX.

## 1. RU - Последующая установка мешочного фильтра VEX350/360

В комплект поставки входят следующие части/узлы:

Алюминиевый профиль	4 шт.
Контроллер алюминиевого профиля	2 шт.
Прокладка	2 шт.
Опорная пластина	2 шт.
Потайная вытяжная заклепка $\varnothing 4$	20 шт.
Вытяжная заклепка $\varnothing 4,8$	14 шт.
Уплотнение	1,2 м

### Внимание!

Мешочные фильтры заказываются отдельно





Перед тем, как открыть дверцу, отключите сетевое электропитание выключателем.

Размещение фильтров варьируется в зависимости от расположения вентилятора/ направления потока воздуха. На иллюстрации показана компактная установка VEX360 с ЛЕВОСТОРОННИМ расположением вентиляторов.

### 1.1 Демонтаж компактных фильтров

Шаг	Действие	Иллюстрация
1.	Вытяните фильтры  NB! Замененные грязные фильтры следует сразу же складывать в полиэтиленовый пакет, который плотно закрывают и утилизируют ответственным образом.	
2.	Удалите направляющие, которые держат компактные фильтры. Вывинтите 2 x 3 вытяжные заклепки сверлом $\varnothing 4$ .	

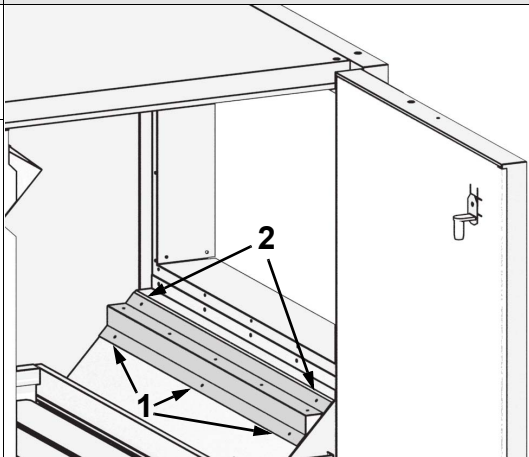
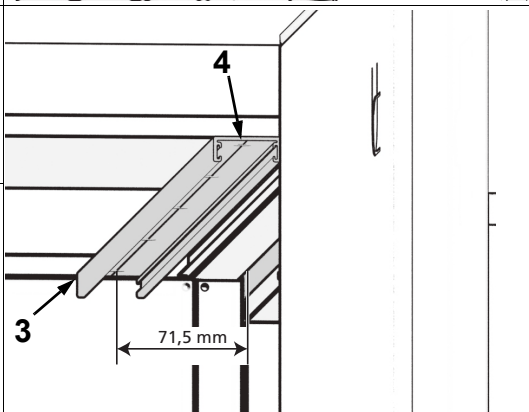
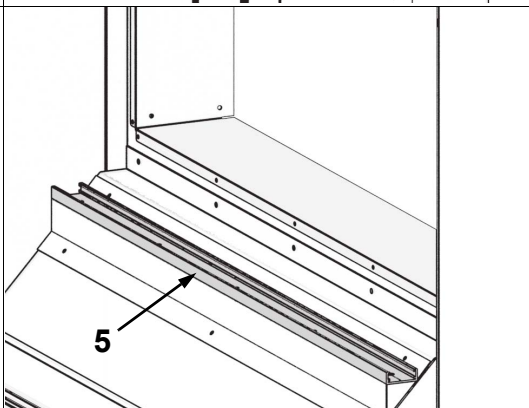
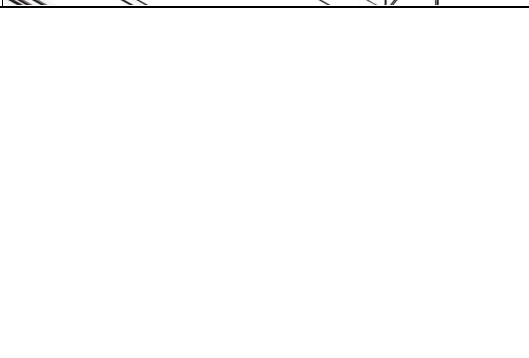
## 1.2 Подготовка к установке мешочных фильтров

Шаг	Действие	Иллюстрация
1.	Закрепите контроллер алюминиевого профиля вытяжными заклепками в три просверленные отверстия.	
2.	Просверлите отверстия $\varnothing 5$ через два других отверстия контроллера. Закрепите с помощью вытяжных заклепок.	
3.	Расположение алюминиевого профиля: Задвиньте профиль до упора по направлению к задней стенке. Расстояние от края корпуса до середины отверстий должно быть 71,5 мм.	
4.	Просверлите отверстия $\varnothing 5$ через 5 отверстий профиля. Закрепите профиль потайными вытяжными заклепками.	
5.	Закрепите профиль на контроллере потайными вытяжными заклепками.	

RD13848-01

RD13849-01

RD13850-01

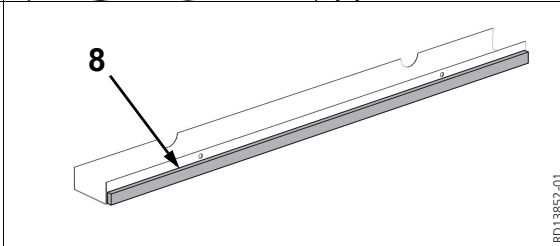
Шаг	Действие	Иллюстрация
6.	Вставьте прокладку в алюминиевые профили по направлению к задней стенке.	
7.	Просверлите отверстия $\varnothing 5$ через отверстия прокладки.	
8.	<p>Наклейте клейкую ленту на прокладку и закрепите ее на задней стенке вытяжными заклепками.</p> <p><b>ВНИМАНИЕ!</b> Проследите за тем, чтобы прокладка была установлена правильной стороной, как показано на рисунке 6.7.</p>	

### 1.3 Установка мешочных фильтров

Шаг	Действие	Иллюстрация
1.	Вставьте наименьший фильтр в профили по направлению к прокладке	
2.	Расположите опорную пластину.	
3.	Вставьте наибольший фильтр.	

Для получения дополнительной информации о замене фильтра см. Руководство к агрегату VEX.







Scan code and go to addresses at  
[www.exhausto.com](http://www.exhausto.com)