

GB

CX3010-CX3020 Wiring diagram

EXcon-automatic

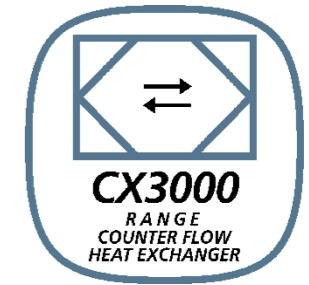

EXHAUSTO A/S
Odensevej 76
DK-5550 Langeskov

Tel. +45 65 66 12 34
Fax +45 65 66 11 10
exhausto@exhausto.dk
www.exhausto.dk

EXHAUSTO

CX3010 & CX3020

0400101

230VAC - Temperature deicing

CX3010: 500 m³/h

CX3020: 900 m³/h

EXHAUSTO	Project: CX3010 & CX3020	Start date: 24-08-2022	Constructor: DKTSA	Page: 1	
		Revision date: 08-11-2023	Approved by: DKLEG	Previous page: 0	
Drawing number: 0400101	Revision: D	Page Title: Project information	Replaces: Rev. C	Scale: 1:1	Next page: 2
			EC no.:	Format:	Pages in total: 39

Page	Title	Page remarks	Last edit
1	Project information		22-12-2022
4	Standards		22-05-2023
5	Component overview		22-12-2022
10	E-box lay-out		26-05-2023
11	Terminals		10-05-2023
12	Main power		10-05-2023
13	Main power		08-11-2023
14	Terminal wiring EXcon Master		22-12-2022
15	Terminal wiring EXT module (1)		22-12-2022
16	Terminal wiring EXT module (2)		22-12-2022
17	PTH connections		22-12-2022
20	Configurations		22-12-2022
21	Configuration 1: No coils		22-12-2022
22	Configuration 2: HCW		22-12-2022
23	Configuration 3: HCE		22-12-2022
24	Configuration 4: CCW		22-12-2022
25	Configuration 5: Preheater		22-12-2022
26	Configuration 6: HCW+CCW		22-12-2022
27	Configuration 7: HCE+CCW		22-12-2022
28	Configuration 8: Preheater+HCW		22-12-2022
29	Configuration 9: Preheater+CCW		08-11-2023
30	Configuration 10: Preheater+HCE		22-12-2022
31	Configuration 11: Preheater+HCW+CCW		08-11-2023
32	Configuration 11: Preheater+HCW+CCW		22-12-2022
33	Configuration 12: Preheater+HCE+CCW		22-12-2022
34	Configuration 12: Preheater+HCE+CCW		22-12-2022
35	Configuration 13: C-O CW (Combi-Coil)		22-12-2022
36	Configuration 14: Preheater+Combi-Coil		22-12-2022
37	Optional accessories		15-06-2023

EXHAUSTO

Project:
CX3010 & CX3020

Start date:	24-08-2022	Constructor:	DKTSA	Page:	2
Revision date:	08-11-2023	Approved by:	DKLEG	Previous page:	1
Replaces:	Rev. C	Scale:	1:1	Next page:	3
EC no.:		Format:		Pages in total:	39

Drawing number:
0400101

Revision:
D

Page Title:
Table of Contents

Page	Title	Page remarks	Last edit
38	Optional accessories MODBUS		29-09-2023
40	Electric heaters		22-12-2022
41	Electric heaters component overview		10-05-2023
42	Electric pre-heater Step 1		08-11-2023
43	Electric heater Step 1		08-11-2023
44	Carlo Gavazzi RG vs Regin TTC25	Difference in wiring of Triac controllers	08-11-2023

EXHAUSTO	Project: CX3010 & CX3020		Start date: 24-08-2022	Constructor: DKTSA	Page: 3
	Page Title: Table of Contents		Revision date: 08-11-2023	Approved by: DKLEG	Previous page: 2
Drawing number: 0400101			Revision: D	Replaces: Rev. C	Scale: 1:1
			EC no.:	Format:	Pages in total: 39

Identification of wires by colour

400/230VAC Main current:

Phase: Black
 Neutral: Blue
 Earth: Green/Yellow

230/24VAC Pilot current:

Phase: Red
 Neutral: Blue
 Earth: Green/Yellow

24VDC Pilot current:

Positive (+): Red
 Negative (-): White

Signals:

Temperature: White
 Dry contact: White
 Analog: White
 Digital: White

Unknown potential:

All: Orange

Abbreviations of colours (according to IEC 60757)

Black	BK
Brown	BN
Red	RD
Orange	OG
Yellow	YE
Green	GN
Blue	BU
Light Blue	BU
Violet	VT
Gray	GY
White	WH
Pink	PK
Gold	GD
Turquoise	TQ
Silver	SR
Green/Yellow	GNYE

Other standards

Labelling of cables and cores (according to IEC 62491): Method CR

Method	Description
0	No labelling
A	Use of designated cables or cores
R	Identification labelling by means of reference designation (including cable number)
CL	Local-end connection labelling
CR	Remote-end connection labelling
CB	Both-end connection labelling
S	Signal labelling

EXHAUSTO

Project:
CX3010 & CX3020

Start date:	24-08-2022	Constructor:	DKTSA	Page:	4
Revision date:	08-11-2023	Approved by:	DKLEG	Previous page:	3
Replaces:	Rev. C	Scale:	1:1	Next page:	5
EC no.:		Format:		Pages in total:	39

Drawing number:
0400101

Revision:
D

Page Title:
Standards

Component	Function	Position
+A1	Control system panel	/10.5
+A2	CX-unit	/10.1
+A3	Coil-box	/10.2
+A4	Customer accessory	/10.2
-BG1	PIR sensor	/37.5
-BQ1	CO2 sensor	/37.6
-BQ2	Air quality sensor	/38.9
-E1	Electrical post-heater	/23.4
-E2	Electrical pre-heater	/25.4
-E3	Combi-coil	/35.4
-F1	Fuse for Main supply	/12.3
-F2	Fuse for EXcon Master	/13.3
-F3	Fuse for external connections	/13.3
-F4	Fuse for Supply fan	/12.5
-F5	Fuse for Exhaust fan	/12.7
-K1	EXcon Master	/14.2
-K27	Extension modul (1)	/15.2
-K30	Extension modul (2)	/16.2
-M1	Supply fan	/12.5
-M2	Exhaust fan	/12.7
-M3	Bypass motor	/14.8
-M4	Circulation pump HCW	/22.0
-M5	Circulation pump CCW	/24.1
-M6	Circulation pump Combi-coil	/35.0
-P1	Dual PTH: Filter pressure	/17.2
-P4	PTH 4000: Constant pressure regulation supply air	/38.5
-P5	PTH 4000: Constant pressure regulation extract air	/38.7
-PH1	HMI standard	/38.1
-PH2	HMI option	/38.7

EXHAUSTO

Project:
CX3010 & CX3020

Start date: 24-08-2022 Constructor: DKTSA Page: 5

Revision date: 08-11-2023 Approved by: DKLEG Previous page: 4

Drawing number:
0400101

Revision:
D

Page Title:
Component overview

Replaces: Rev. C Scale: 1:1 Next page: 6

EC no.: Format: Pages in total: 39

Component	Function	Position
-R1	Resistor for +10V to Exhaust air fan	/15.2
-R2	Resistor for +10V to Supply air fan	/15.3
-S1	Main switch	/12.1
-T1	Power supply 230VAC/2x24VDC	/13.3
-TE1.1	Extract air temperature	/15.5
-TE1.2	Exhaust air temperature	/17.3
-TE2.1	Outdoor air temperature	/17.3
-TE2.1-PRHE	Outdoor air temperature before pre-heater	/25.7
-TE2.2	Supply air temperature	/21.7
-TE-OT	Outdoor temperature	/38.3
-TE-RPT	Clamp-on temp. sensor RPT HCW	/22.6
-TE-RPT-CC	Clamp-on temp. sensor RPT Combi-Co	/35.6
-TE-RT	Room temperature	/38.5
-TE-SPT	Clamp-on temp. sensor SPT CCW	/24.7
-W1	Main power supply cable	/12.1
-X1	Terminals for Main supply	/12.1
-X1_EXT(2)	Terminals for Coil-box	/16.2
-X2	Terminals for fans	/12.5
-X3	Terminal for fuses 24V	/13.3
-X4	Terminals for Circulation pumps 230V	/13.8
-X5	Terminals for External customer connections	/15.5
-X_BP	Plug bypass motor	/14.8
-X_FAN EX	Plug Exhaust fan	/12.7
-X_FAN SU	Plug Supply fan	/12.5
-X_RJ12.3	Modbus T-split	/38.2
-Y1	Valve HCW	/22.2
-Y2	Valve CCW	/24.2
-Y3	Valve Combi-coil	/35.2

EXHAUSTO

Project:
CX3010 & CX3020

Start date:	24-08-2022	Constructor:	DKTSA	Page:	6
Revision date:	08-11-2023	Approved by:	DKLEG	Previous page:	5
Replaces:	Rev. C	Scale:	1:1	Next page:	10
EC no.:		Format:		Pages in total:	39

Drawing number:
0400101

Revision:
D

Page Title:
Component overview

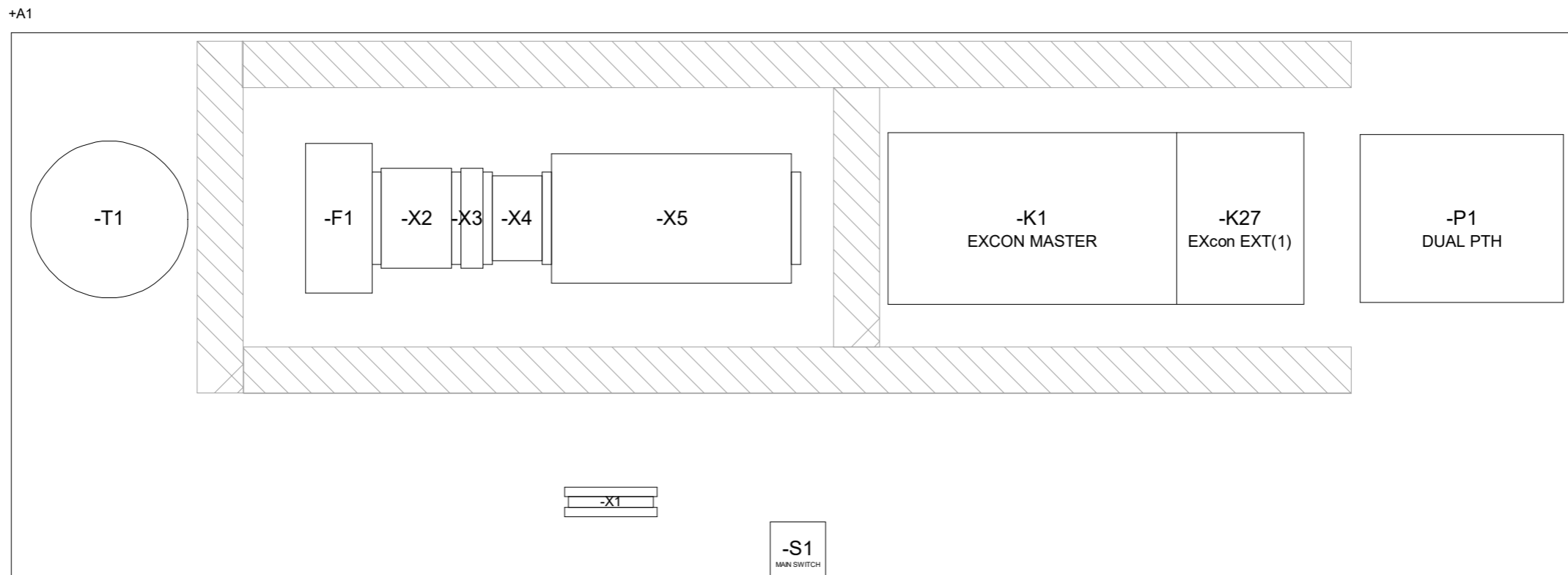

EXHAUSTO	Project: CX3010 & CX3020	Start date: 24-08-2022	Constructor: DKTSA	Page: 10	
		Revision date: 08-11-2023	Approved by: DKLEG	Previous page: 6	
Drawing number: 0400101	Revision: D	Page Title: E-box lay-out	Replaces: Rev. C	Scale: 1:3	Next page: 11
			EC no.:	Format:	Pages in total: 39

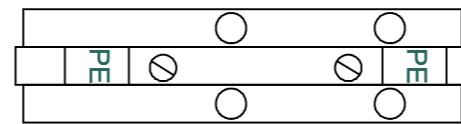
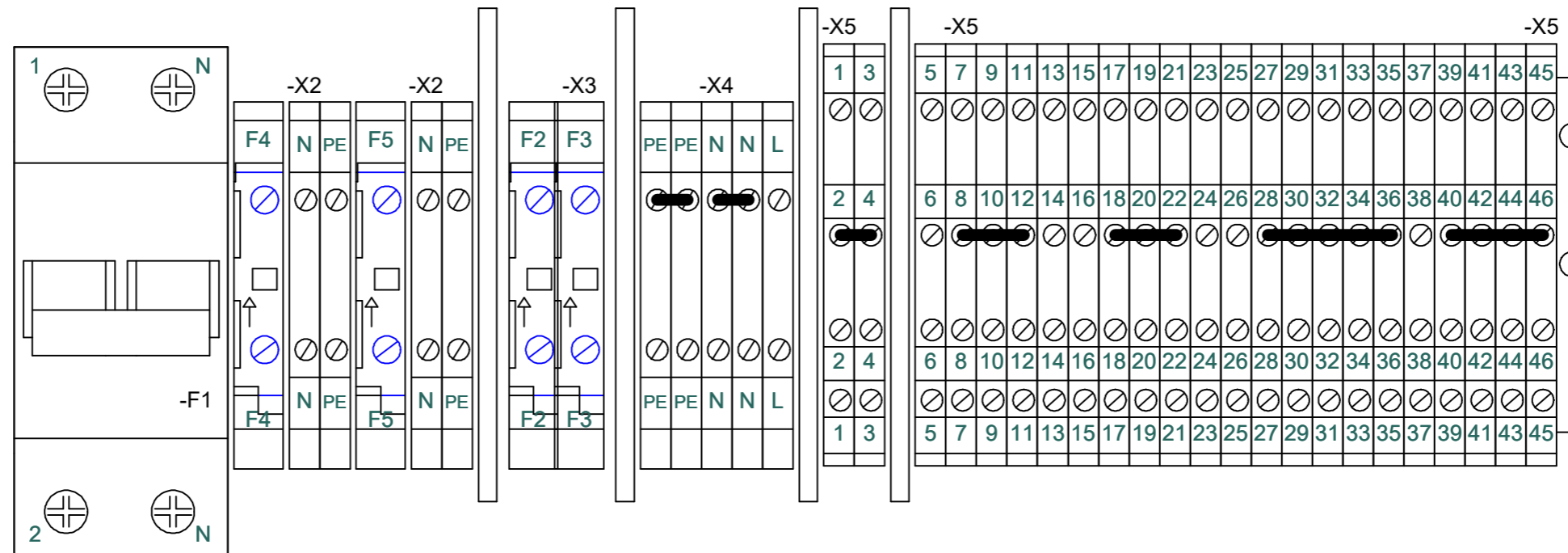

EXHAUSTO

Project:
CX3010 & CX3020

Start date: 24-08-2022 Constructor: DKTSA Page: 11

Revision date: 08-11-2023 Approved by: DKLEG Previous page: 10

Drawing number:
0400101

Revision:
D

Page Title:
Terminals

Replaces: Rev. C Scale: 1:1 Next page: 12

EC no.: Format: Pages in total: 39

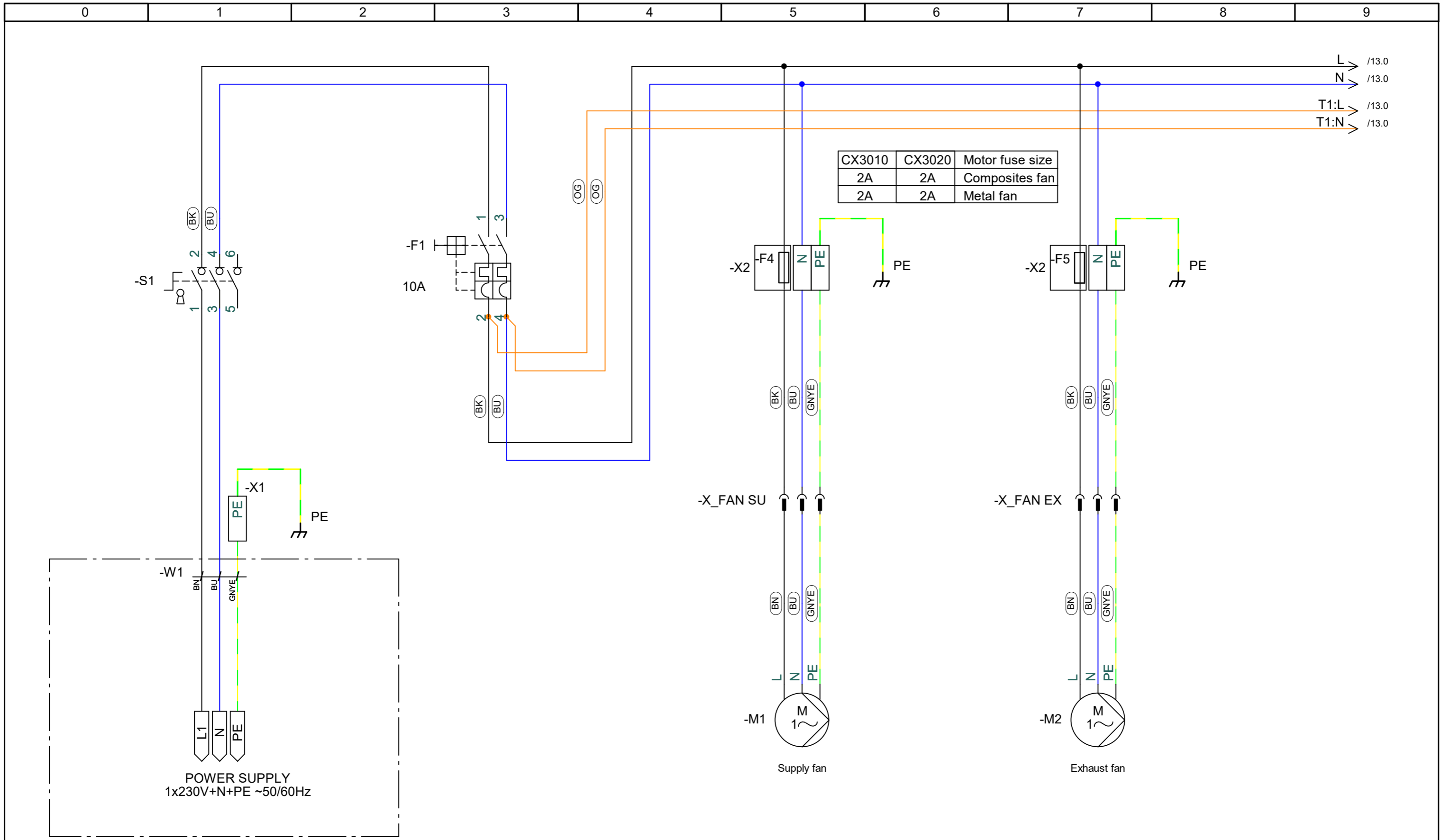

EXHAUSTO

Project:
CX3010 & CX3020

Start date:	24-08-2022	Constructor:	DKTSA	Page:	12
Revision date:	08-11-2023	Approved by:	DKLEG	Previous page:	11
Replaces:	Rev. C	Scale:	1:1	Next page:	13
EC no.:		Format:		Pages in total:	39

Drawing number:
0400101

Revision:
D

Page Title:
Main power

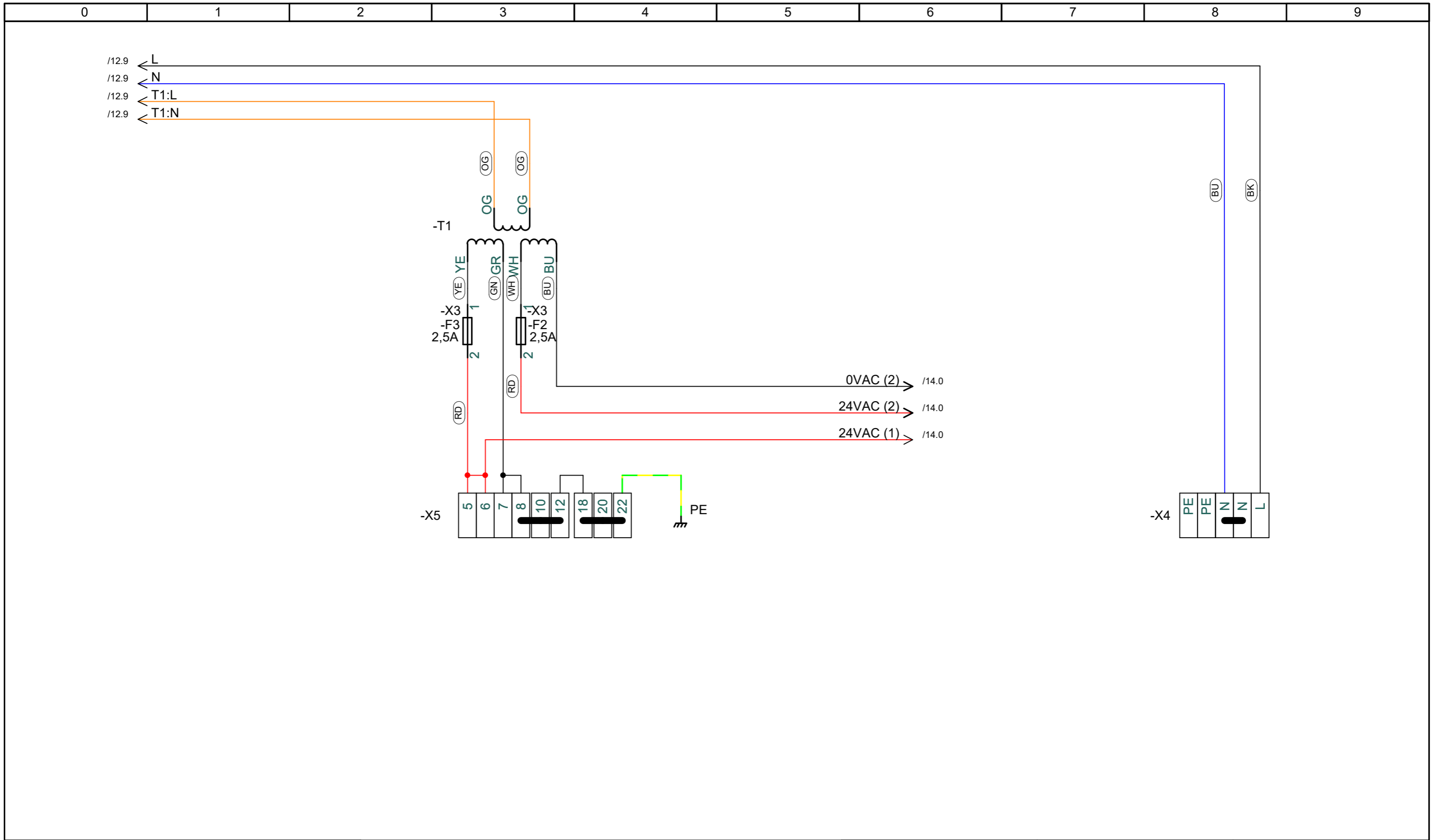

EXHAUSTO	Project: CX3010 & CX3020		Start date: 24-08-2022	Constructor: DKTSA	Page: 13
	Revision: D		Revision date: 08-11-2023	Approved by: DKLEG	Previous page: 12
Drawing number: 0400101	Page Title: Main power		Replaces: Rev. C	Scale: 1:1	Next page: 14
			EC no.:	Format:	Pages in total: 39

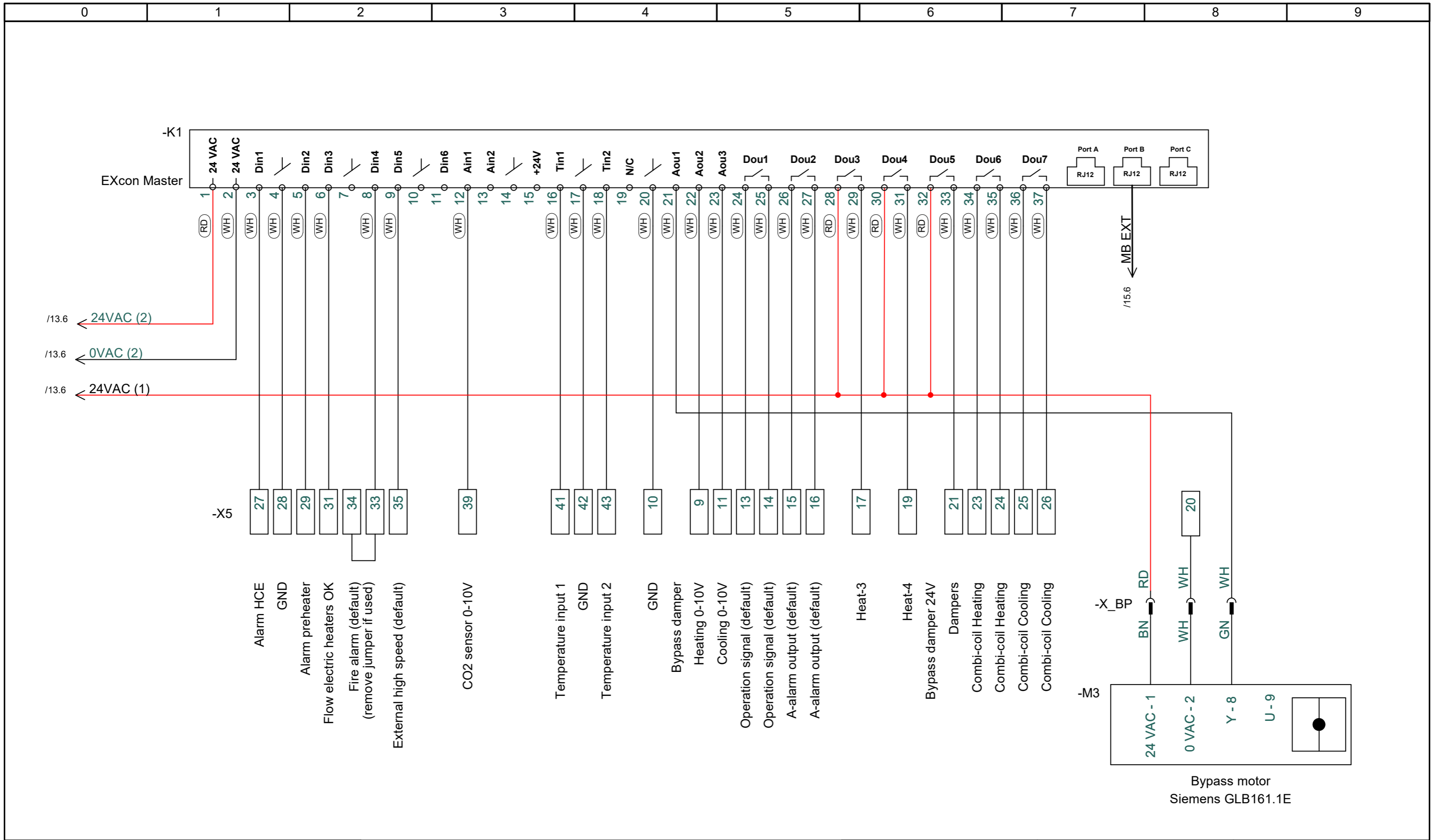

EXHAUSTO	Project:	CX3010 & CX3020	Start date:	24-08-2022	Constructor:	DKTSA	Page:	14			
	Drawing number:	0400101	Revision:	D	Page Title:	Terminal wiring EXcon Master	Revision date:	08-11-2023	Approved by:	DKLEG	Previous page:
			Replaces:	Rev. C	Scale:	1:1	Next page:	15			
			EC no.:		Format:		Pages in total:	39			

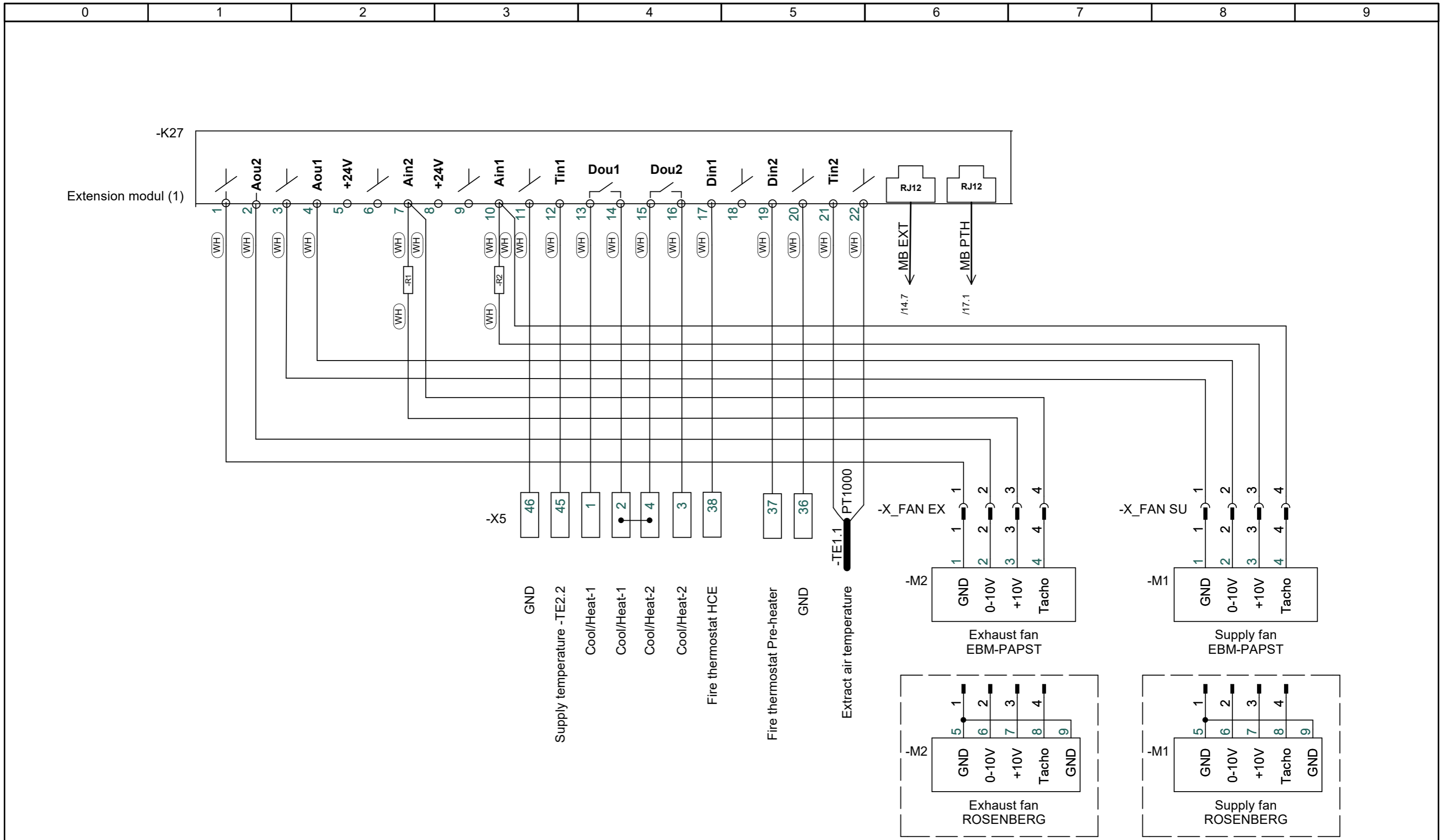

EXHAUSTO

Project:
CX3010 & CX3020

Start date:	24-08-2022	Constructor:	DKTSA	Page:	15
Revision date:	08-11-2023	Approved by:	DKLEG	Previous page:	14
Replaces:	Rev. C	Scale:	1:1	Next page:	16
EC no.:		Format:		Pages in total:	39

Drawing number:
0400101

Revision:
D

Page Title:
Terminal wiring EXT module (1)

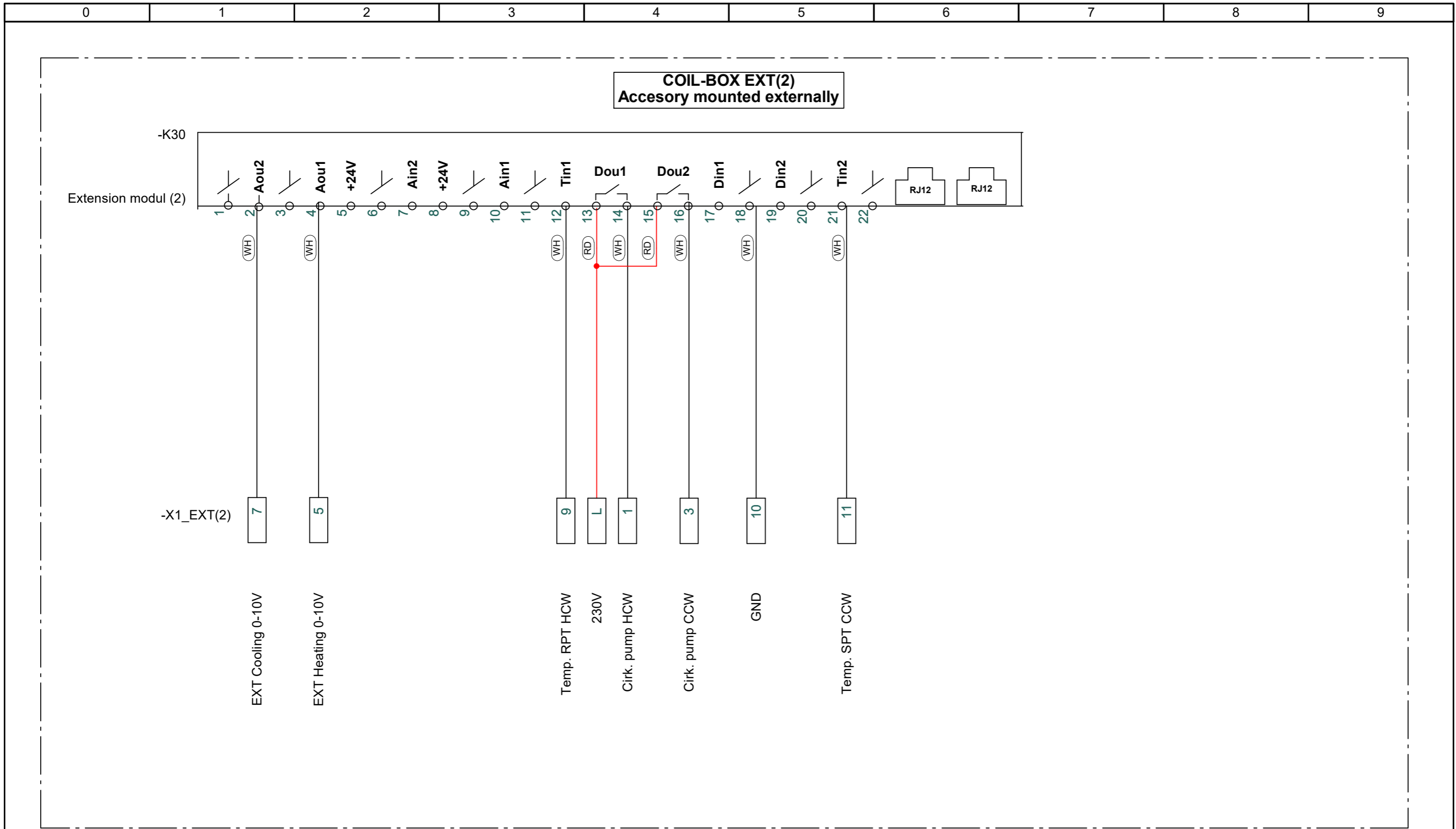

EXHAUSTO	Project: CX3010 & CX3020		Start date: 24-08-2022	Constructor: DKTSA	Page: 16
	Page Title: Terminal wiring EXT module (2)		Revision date: 08-11-2023	Approved by: DKLEG	Previous page: 15
Drawing number: 0400101	Revision: D		Replaces: Rev. C	Scale: 1:1	Next page: 17
			EC no.:	Format:	Pages in total: 39

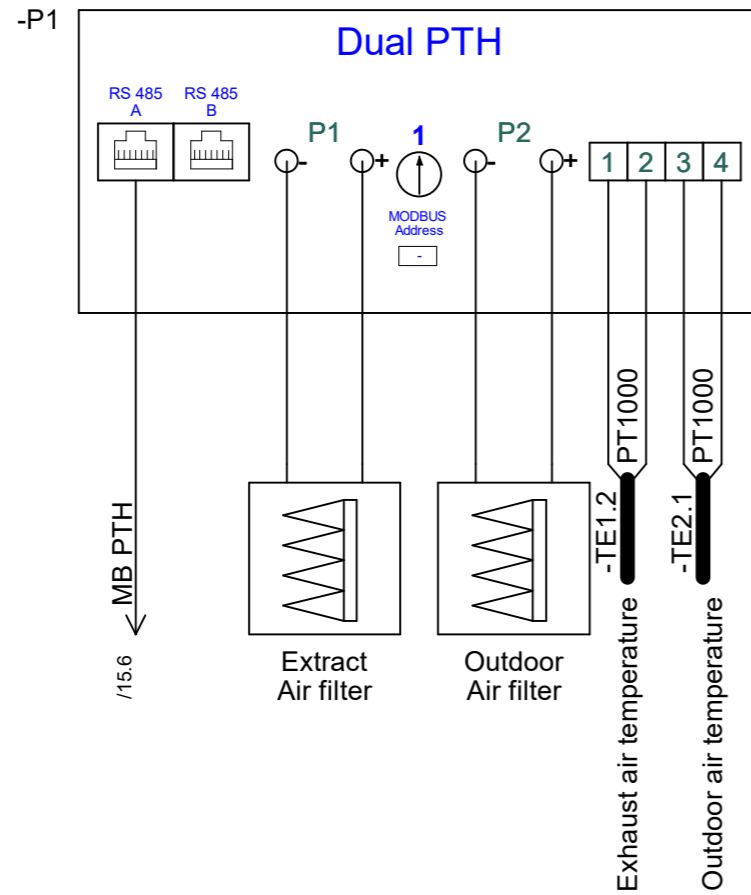

**When external -TE2.1-PRHE sensor is mounted, this is used as outdoor temperature sensor and -TE2.1 is used as preheater temperature sensor.*

EXHAUSTO

Project:
CX3010 & CX3020

Start date:	24-08-2022	Constructor:	DKTSA	Page:	17
Revision date:	08-11-2023	Approved by:	DKLEG	Previous page:	16
Replaces:	Rev. C	Scale:	1:1	Next page:	20
EC no.:		Format:		Pages in total:	39

Drawing number:
0400101

Revision:
D

Page Title:
PTH connections

Configurations

EXHAUSTO	Project: CX3010 & CX3020	Start date: 24-08-2022	Constructor: DKTSA	Page: 20	
		Revision date: 08-11-2023	Approved by: DKLEG	Previous page: 17	
Drawing number: 0400101	Revision: D	Page Title: Configurations	Replaces: Rev. C	Scale: 1:1	Next page: 21
			EC no.:	Format:	Pages in total: 39

Configuration 1: No Coils

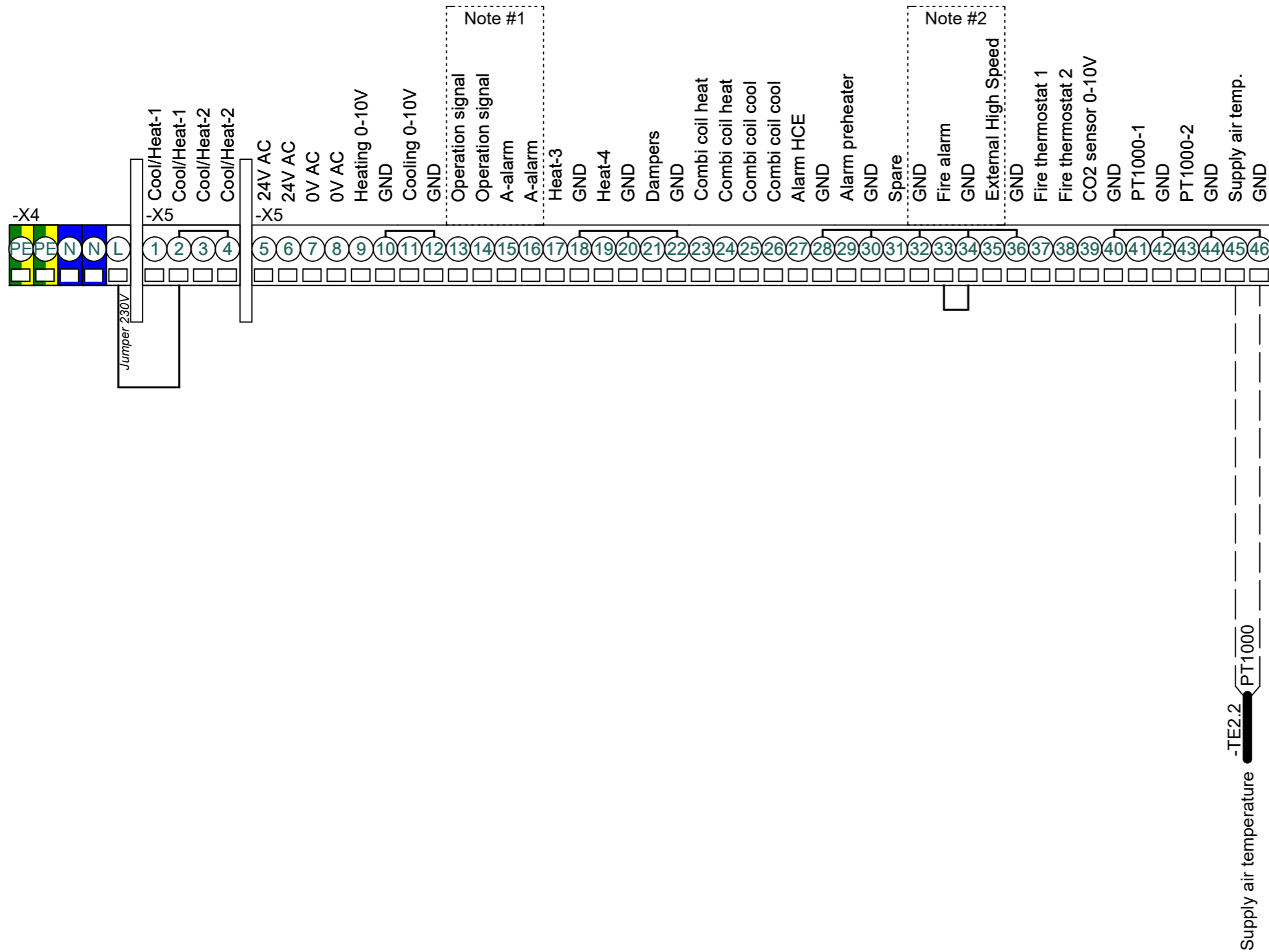

Note #1
 Default configuration.
 Can be changed to:
 - B-alarm output
 - Alarm reset
 - Summer operation
 - Summer night cooling

Note #2
 Default configuration.
 Can be changed to:
 - AHU STOP
 - Low speed
 - Medium speed
 - Frost alarm
 - External start
 - External reset alarms
 If used remove jumper

* Supply air temperature sensor must be mounted in supply air duct after heating and cooling coils

EXHAUSTO	Project:	CX3010 & CX3020	Start date:	24-08-2022	Constructor:	DKTSA	Page:	21			
	Drawing number:	0400101	Revision:	D	Page Title:	Configuration 1: No coils	Revision date:	08-11-2023	Approved by:	DKLEG	Previous page:
					Replaces:	Rev. C	Scale:	1:1	Next page:	22	
					EC no.:		Format:		Pages in total:	39	

Configuration 2: Water Heating Coil

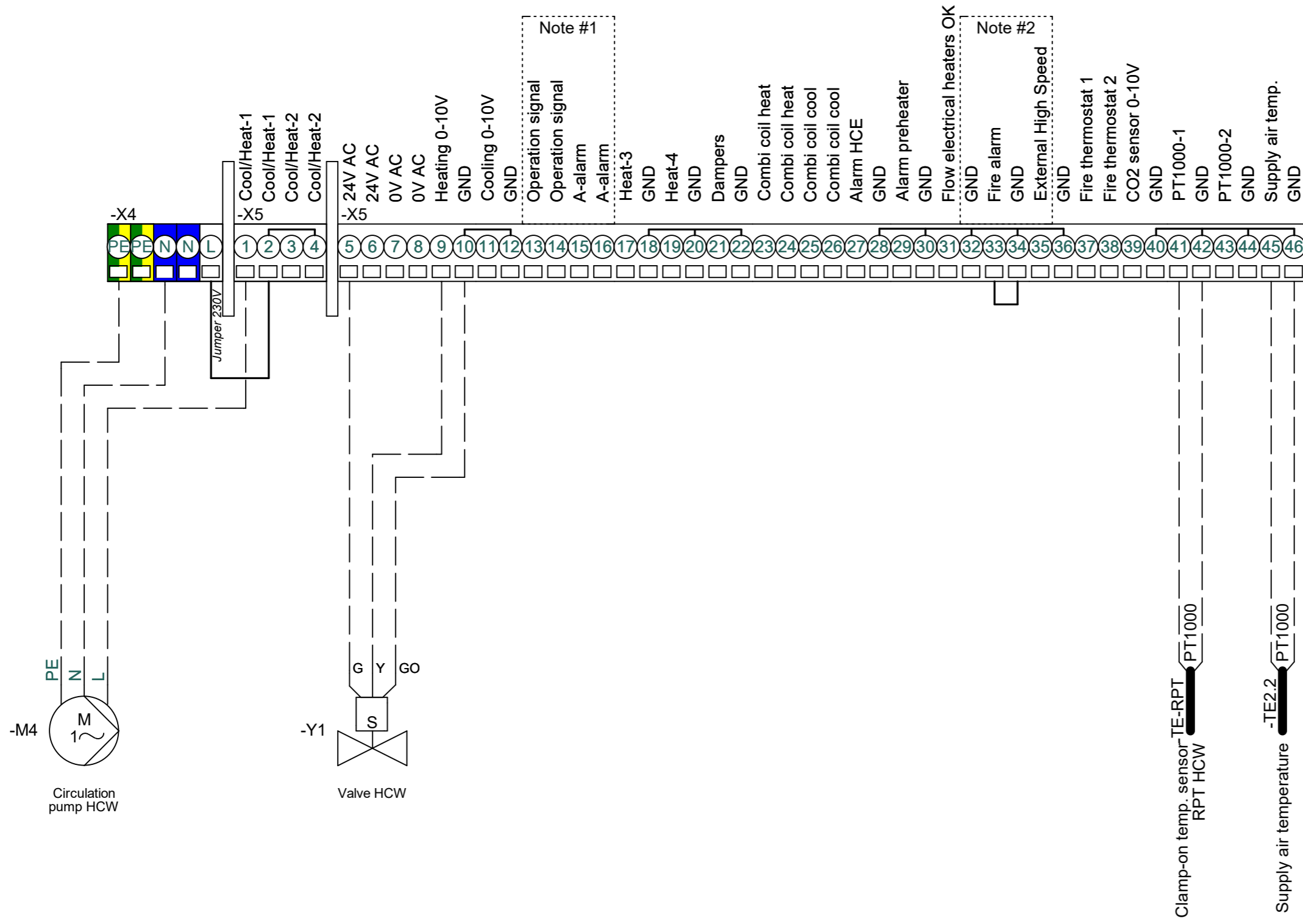

Note #1
 Default configuration.
 Can be changed to:
 - B-alarm output
 - Alarm reset
 - Summer operation
 - Summer night cooling

Note #2
 Default configuration.
 Can be changed to:
 - AHU STOP
 - Low speed
 - Medium speed
 - Frost alarm
 - External start
 - External reset alarms
 If used remove jumper

* Supply air temperature sensor must be mounted in supply air duct after heating and cooling coils

EXHAUSTO	Project:	CX3010 & CX3020	Start date:	24-08-2022	Constructor:	DKTSA	Page:	22			
	Drawing number:	0400101	Revision:	D	Page Title:	Configuration 2: HCW	Revision date:	08-11-2023	Approved by:	DKLEG	Previous page:
			Replaces:	Rev. C	Scale:	1:1	Next page:	23			
			EC no.:		Format:		Pages in total:	39			

Configuration 3: Electric Heating Coil

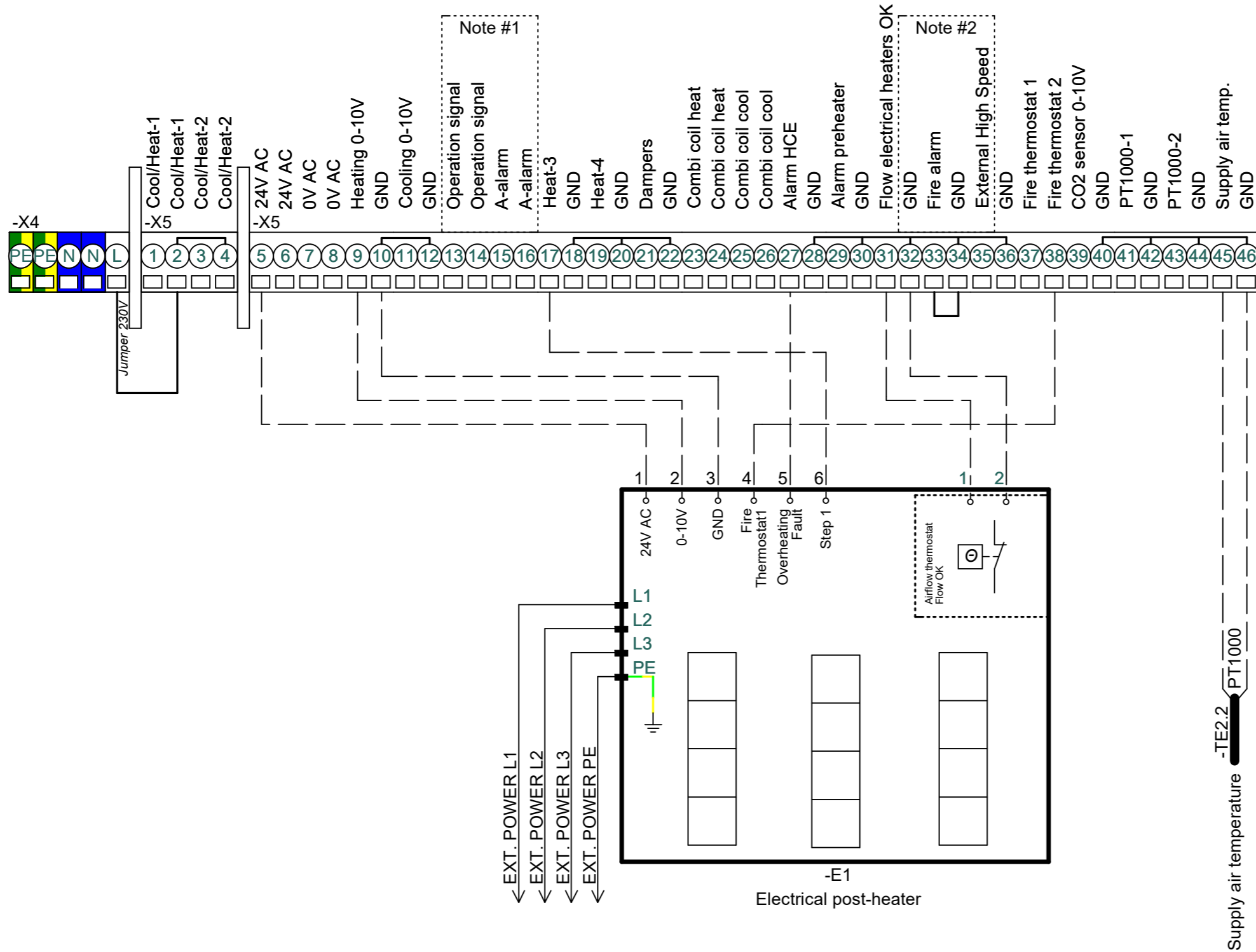

Note #1
 Default configuration.
 Can be changed to:
 - B-alarm output
 - Alarm reset
 - Summer operation
 - Summer night cooling

Note #2
 Default configuration.
 Can be changed to:
 - AHU STOP
 - Low speed
 - Medium speed
 - Frost alarm
 - External start
 - External reset alarms
 If used remove jumper

* Supply air temperature sensor must be mounted in supply air duct after heating and cooling coils

EXHAUSTO	Project:	CX3010 & CX3020	Start date:	24-08-2022	Constructor:	DKTSA	Page:	23			
	Drawing number:	0400101	Revision:	D	Page Title:	Configuration 3: HCE	Revision date:	08-11-2023	Approved by:	DKLEG	Previous page:
			Replaces:	Rev. C	Scale:	1:1	Next page:	24			
			EC no.:		Format:		Pages in total:	39			

Configuration 4: Water Cooling Coil

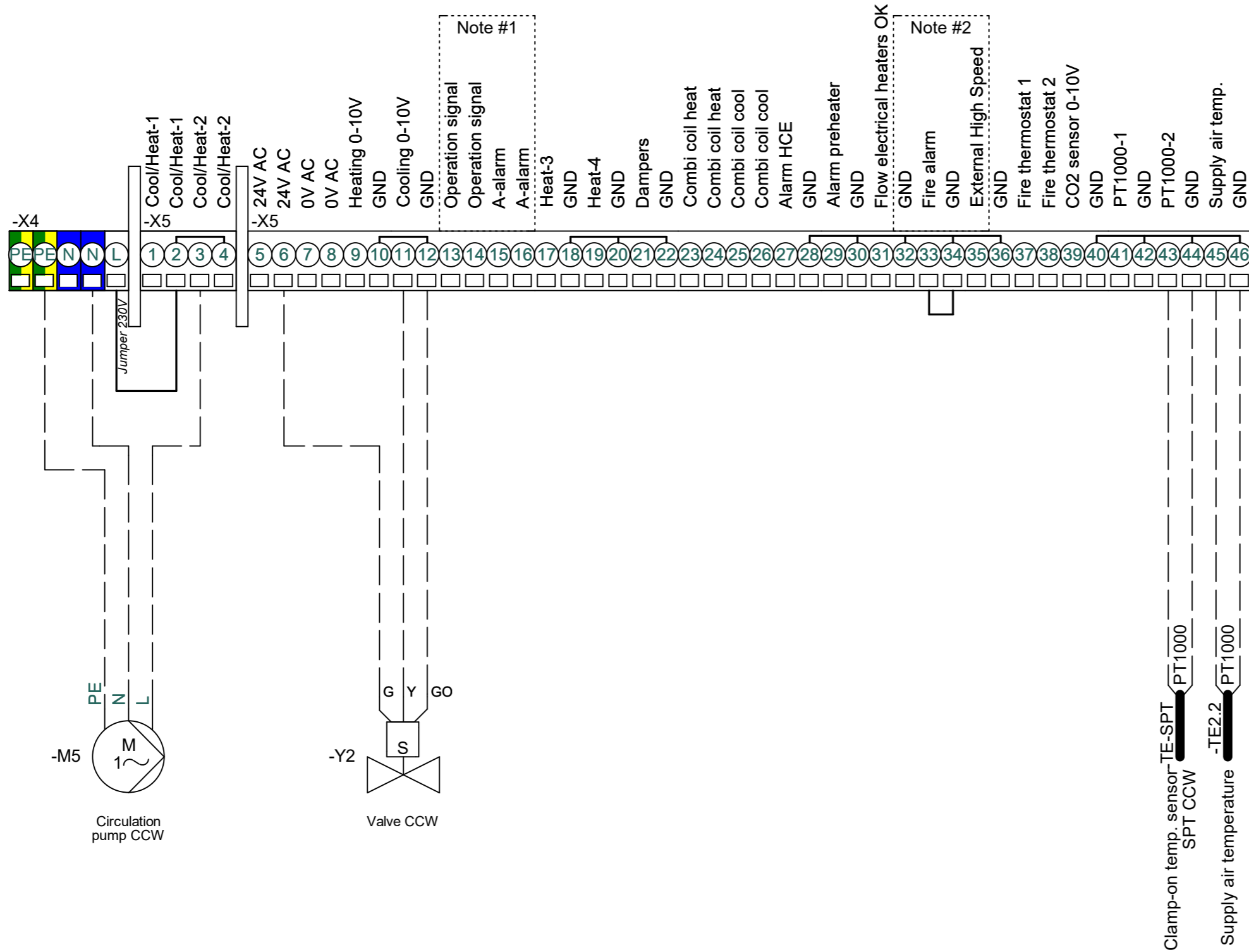

Note #1
 Default configuration.
 Can be changed to:
 - B-alarm output
 - Alarm reset
 - Summer operation
 - Summer night cooling

Note #2
 Default configuration.
 Can be changed to:
 - AHU STOP
 - Low speed
 - Medium speed
 - Frost alarm
 - External start
 - External reset alarms
 If used remove jumper

* Supply air temperature sensor must be mounted in supply air duct after heating and cooling coils

EXHAUSTO	Project:	CX3010 & CX3020	Start date:	24-08-2022	Constructor:	DKTSA	Page:	24			
	Drawing number:	0400101	Revision:	D	Page Title:	Configuration 4: CCW	Revision date:	08-11-2023	Approved by:	DKLEG	Previous page:
			Replaces:	Rev. C	Scale:	1:1	Next page:	25			
			EC no.:		Format:		Pages in total:	39			

Configuration 5: Electric Pre-heater

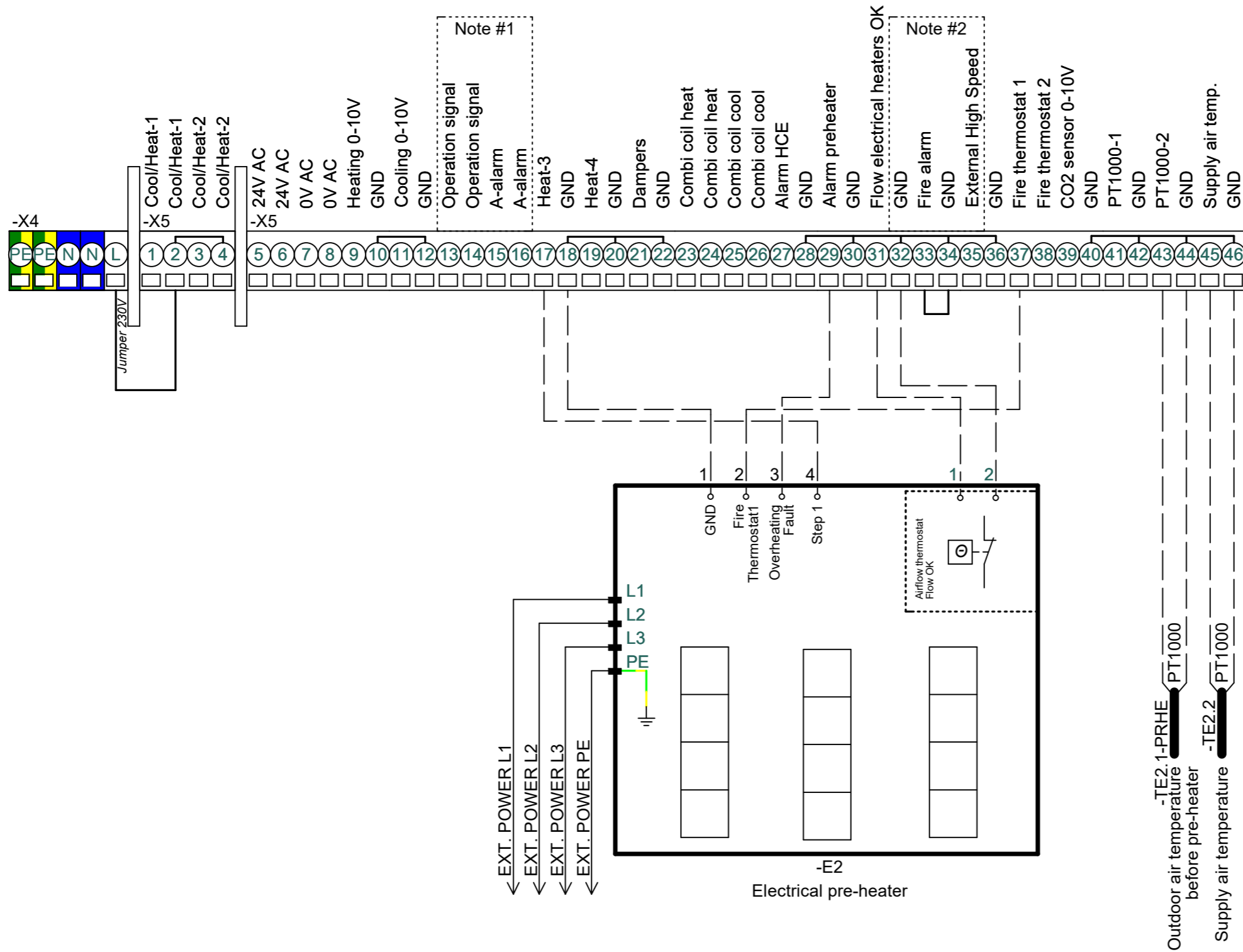

Note #1
 Default configuration.
 Can be changed to:
 - B-alarm output
 - Alarm reset
 - Summer operation
 - Summer night cooling

Note #2
 Default configuration.
 Can be changed to:
 - AHU STOP
 - Low speed
 - Medium speed
 - Frost alarm
 - External start
 - External reset alarms
 If used remove jumper

* Outdoor air temperature sensor must be mounted in the outside air duct, before the preheating coil.

* Supply air temperature sensor must be mounted in supply air duct after heating and cooling coils

	Project:	CX3010 & CX3020	Start date:	24-08-2022	Constructor:	DKTSA	Page:	25			
	Drawing number:	0400101	Revision:	D	Page Title:	Configuration 5: Preheater	Revision date:	08-11-2023	Approved by:	DKLEG	Previous page:
					Replaces:	Rev. C	Scale:	1:1	Next page:	26	
					EC no.:		Format:		Pages in total:	39	

Configuration 6: Water Heating Coil + Water cooling coil

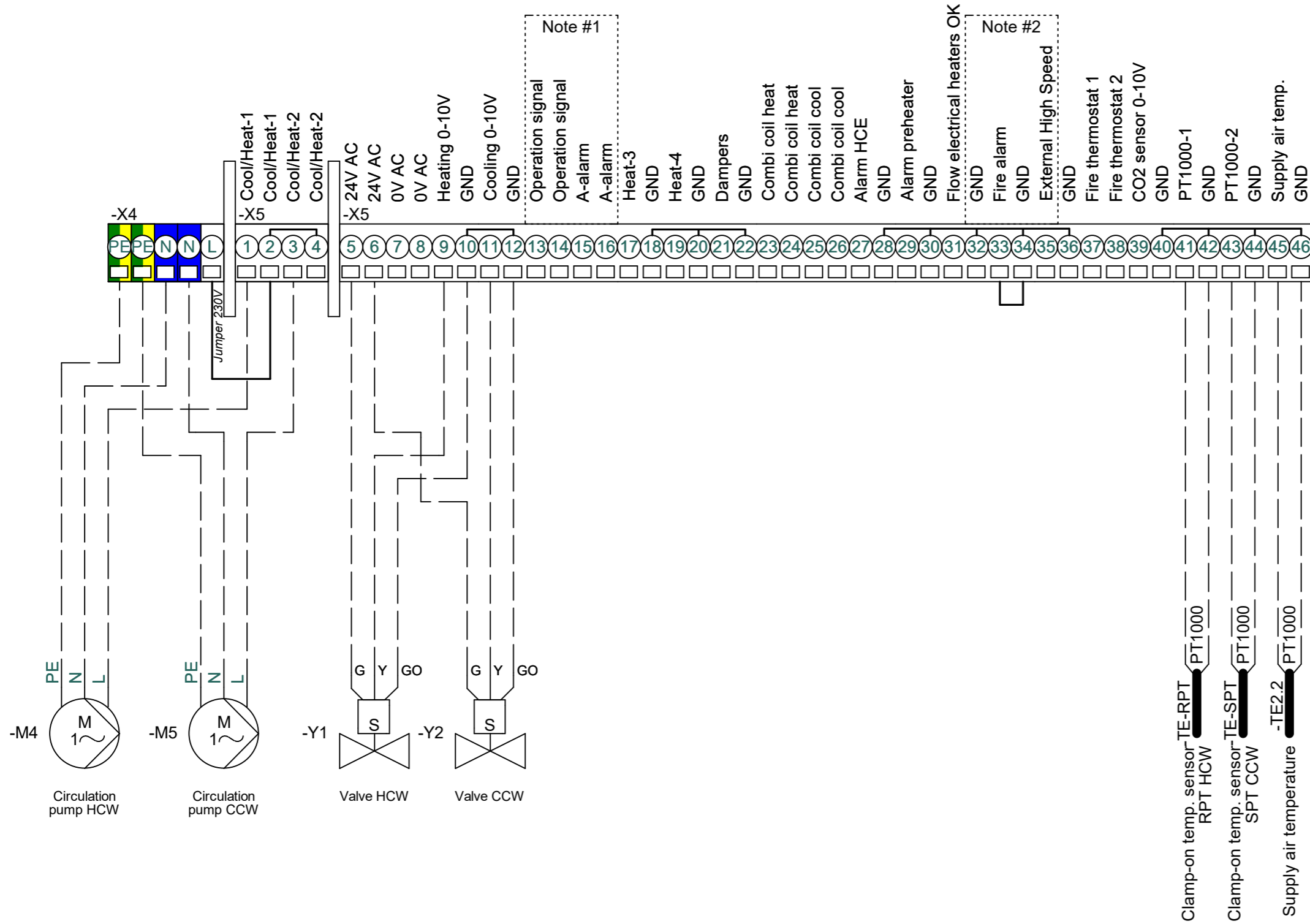

Note #1
 Default configuration.
 Can be changed to:
 - B-alarm output
 - Alarm reset
 - Summer operation
 - Summer night cooling

Note #2
 Default configuration.
 Can be changed to:
 - AHU STOP
 - Low speed
 - Medium speed
 - Frost alarm
 - External start
 - External reset alarms
 If used remove jumper

* Supply air temperature sensor must be mounted in supply air duct after heating and cooling coils

EXHAUSTO	Project:	CX3010 & CX3020	Start date:	24-08-2022	Constructor:	DKTSA	Page:	26	
	Drawing number:	0400101	Revision:	D	Revision date:	08-11-2023	Approved by:	DKLEG	Previous page:
Page Title:		Configuration 6: HCW+CCW	Replaces:	Rev. C	Scale:	1:1	Next page:	27	
			EC no.:		Format:		Pages in total:	39	

Connections configuration 7: Electric Heating Coil + Water Cooling Coil

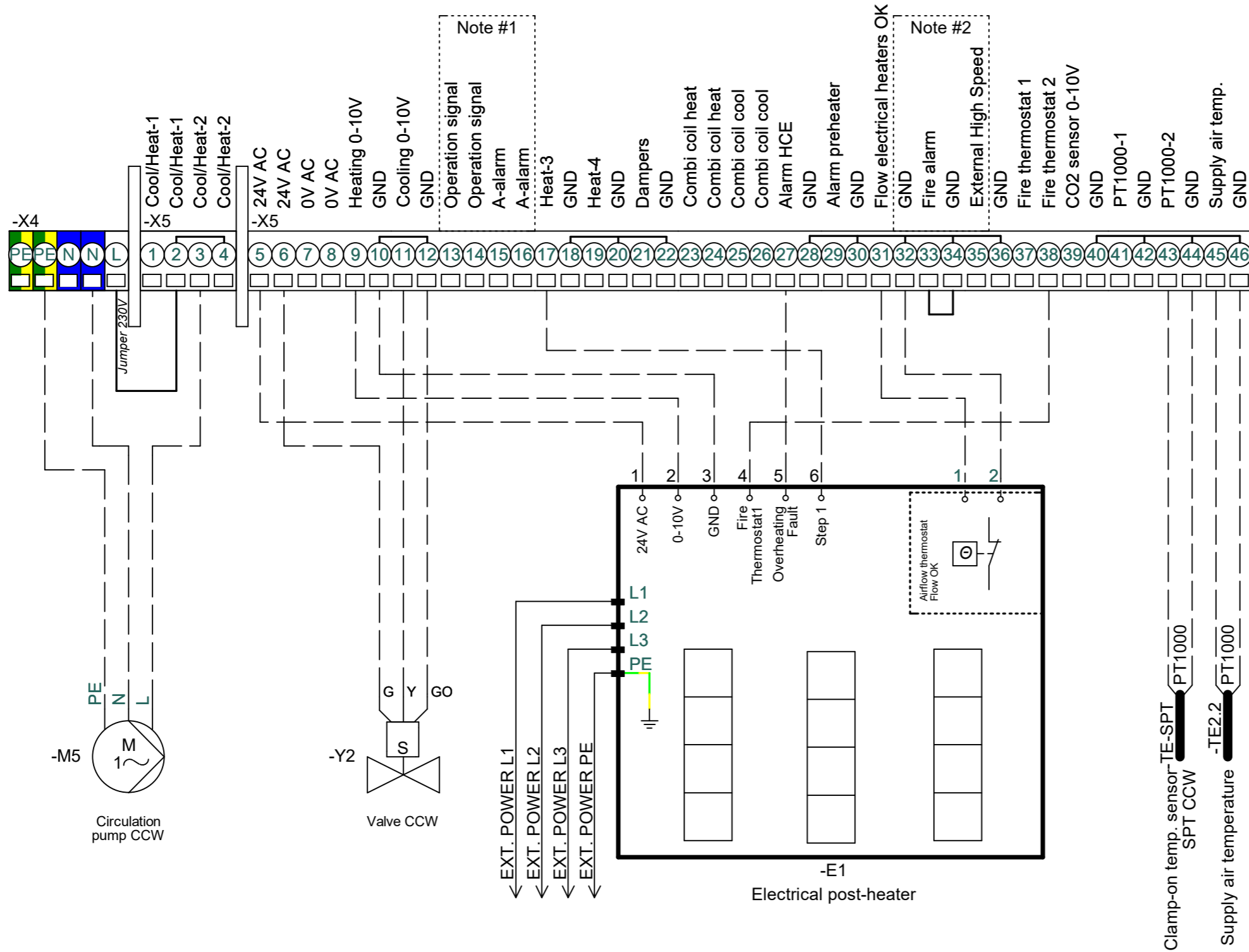

Note #1
 Default configuration.
 Can be changed to:
 - B-alarm output
 - Alarm reset
 - Summer operation
 - Summer night cooling

Note #2
 Default configuration.
 Can be changed to:
 - AHU STOP
 - Low speed
 - Medium speed
 - Frost alarm
 - External start
 - External reset alarms
 If used remove jumper

* Supply air temperature sensor must be mounted in supply air duct after heating and cooling coils

EXHAUSTO

Project:
CX3010 & CX3020

Start date:	24-08-2022	Constructor:	DKTSA	Page:	27
Revision date:	08-11-2023	Approved by:	DKLEG	Previous page:	26
Replaces:	Rev. C	Scale:	1:1	Next page:	28
EC no.:		Format:		Pages in total:	39

Drawing number:
0400101

Revision:
D

Page Title:
Configuration 7: HCE+CCW

Connections configuration 8: Electric Preheating Coil + Water Heating Coil

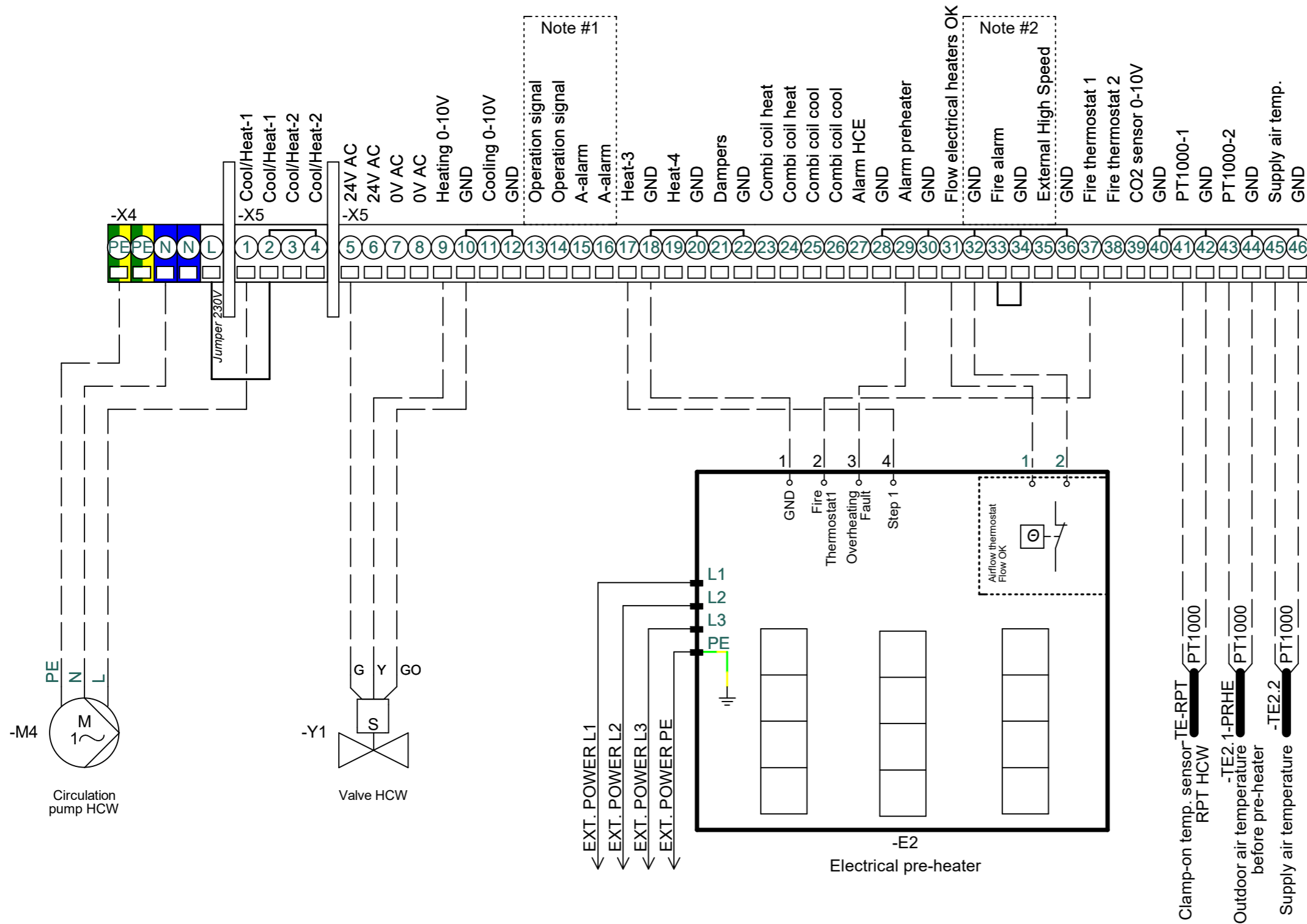

Note #1
 Default configuration.
 Can be changed to:
 - B-alarm output
 - Alarm reset
 - Summer operation
 - Summer night cooling

Note #2
 Default configuration.
 Can be changed to:
 - AHU STOP
 - Low speed
 - Medium speed
 - Frost alarm
 - External start
 - External reset alarms
 If used remove jumper

* Outdoor air temperature sensor must be mounted in the outside air duct, before the preheating coil.
 * Supply air temperature sensor must be mounted in supply air duct after heating and cooling coils

EXHAUSTO	Project:	CX3010 & CX3020	Start date:	24-08-2022	Constructor:	DKTSA	Page:	28	
	Drawing number:	0400101	Revision:	D	Revision date:	08-11-2023	Approved by:	DKLEG	Previous page:
Page Title:		Configuration 8: Preheater+HCW	Replaces:	Rev. C	Scale:	1:1	Next page:	29	
			EC no.:		Format:		Pages in total:	39	

Connections configuration 9: Electric Preheating Coil + Water Cooling Coil

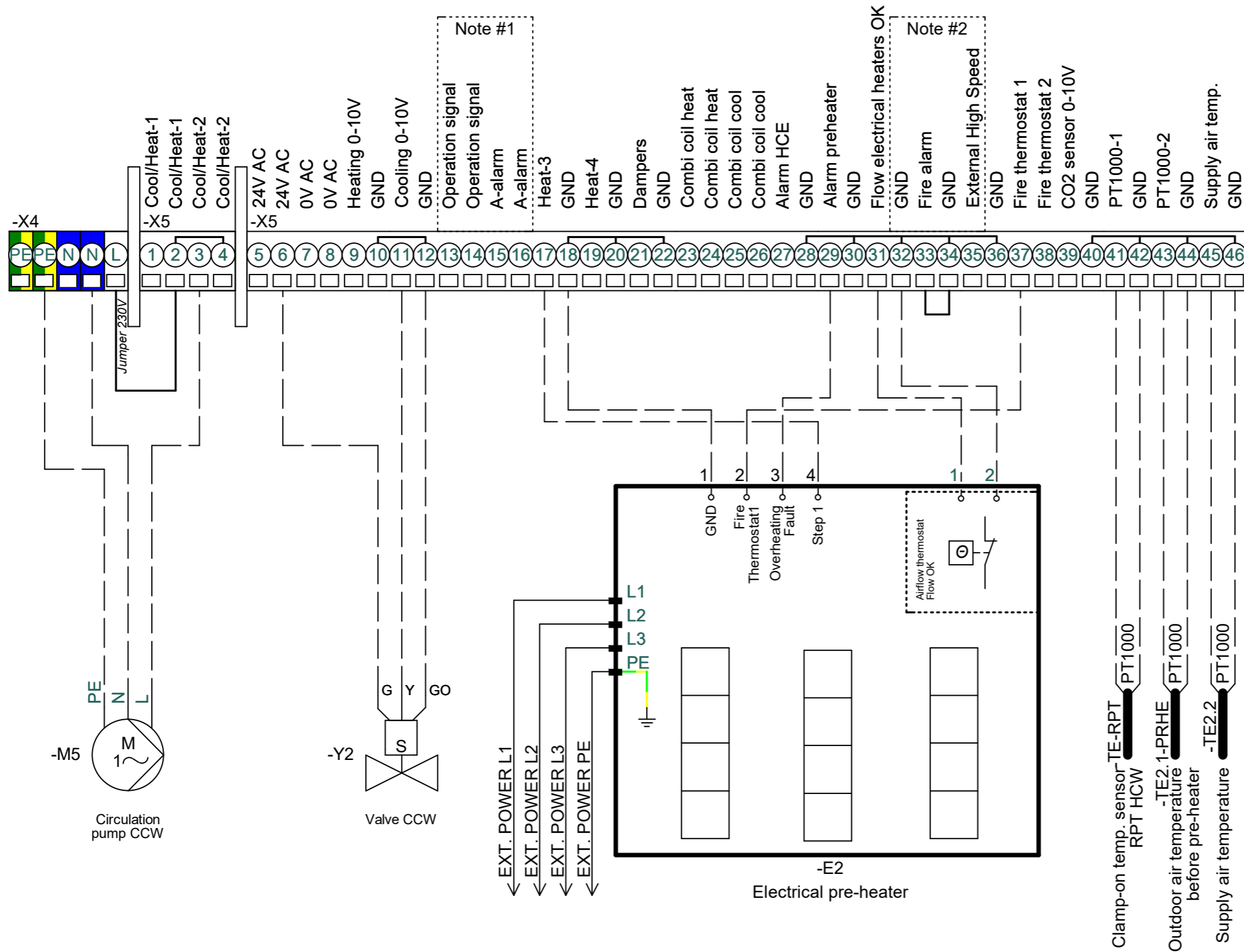

Note #1
 Default configuration.
 Can be changed to:
 - B-alarm output
 - Alarm reset
 - Summer operation
 - Summer night cooling

Note #2
 Default configuration.
 Can be changed to:
 - AHU STOP
 - Low speed
 - Medium speed
 - Frost alarm
 - External start
 - External reset alarms
 If used remove jumper

* Outdoor air temperature sensor must be mounted in the outside air duct, before the preheating coil.

* Supply air temperature sensor must be mounted in supply air duct after heating and cooling coils

EXHAUSTO	Project:	CX3010 & CX3020	Start date:	24-08-2022	Constructor:	DKTSA	Page:	29	
	Drawing number:	0400101	Revision:	D	Revision date:	08-11-2023	Approved by:	DKLEG	Previous page:
	Page Title:	Configuration 9: Preheater+CCW	Replaces:	Rev. C	Scale:	1:1	Next page:	30	
			EC no.:		Format:		Pages in total:	39	

Connections configuration 10: Electric Preheating Coil + Electric Postheating Coil

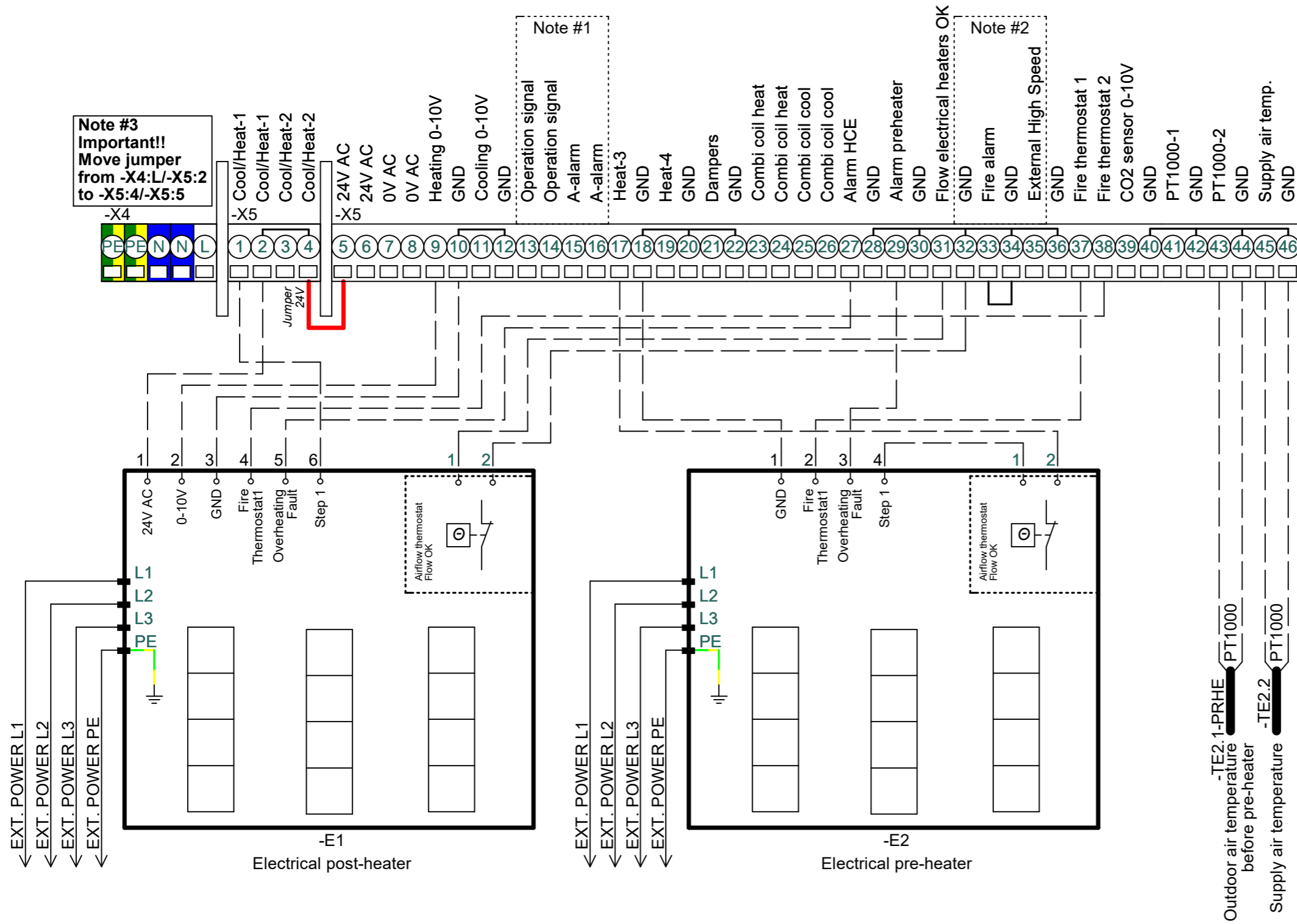

Note #3
Important!!
Move jumper
from -X4:L/-X5:2
to -X5:4/-X5:5

Note #1

Note #2

Note #1
Default configuration.
Can be changed to:
- B-alarm output
- Alarm reset
- Summer operation
- Summer night cooling

Note #2
Default configuration.
Can be changed to:
- AHU STOP
- Low speed
- Medium speed
- Frost alarm
- External start
- External reset alarms
If used remove jumper

* Outdoor air temperature sensor must be mounted in the outside air duct, before the preheating coil.

* Supply air temperature sensor must be mounted in supply air duct after heating and cooling coils

	Project:	CX3010 & CX3020	Start date:	24-08-2022	Constructor:	DKTSA	Page:	30			
	Drawing number:	0400101	Revision:	D	Page Title:	Configuration 10: Preheater+HCE	Revision date:	08-11-2023	Approved by:	DKLEG	Previous page:
					Replaces:	Rev. C	Scale:	1:1	Next page:	31	
					EC no.:		Format:		Pages in total:	39	

Configuration 11: Preheater + Water Heating Coil + Water Cooling Coil

Continued on page 32

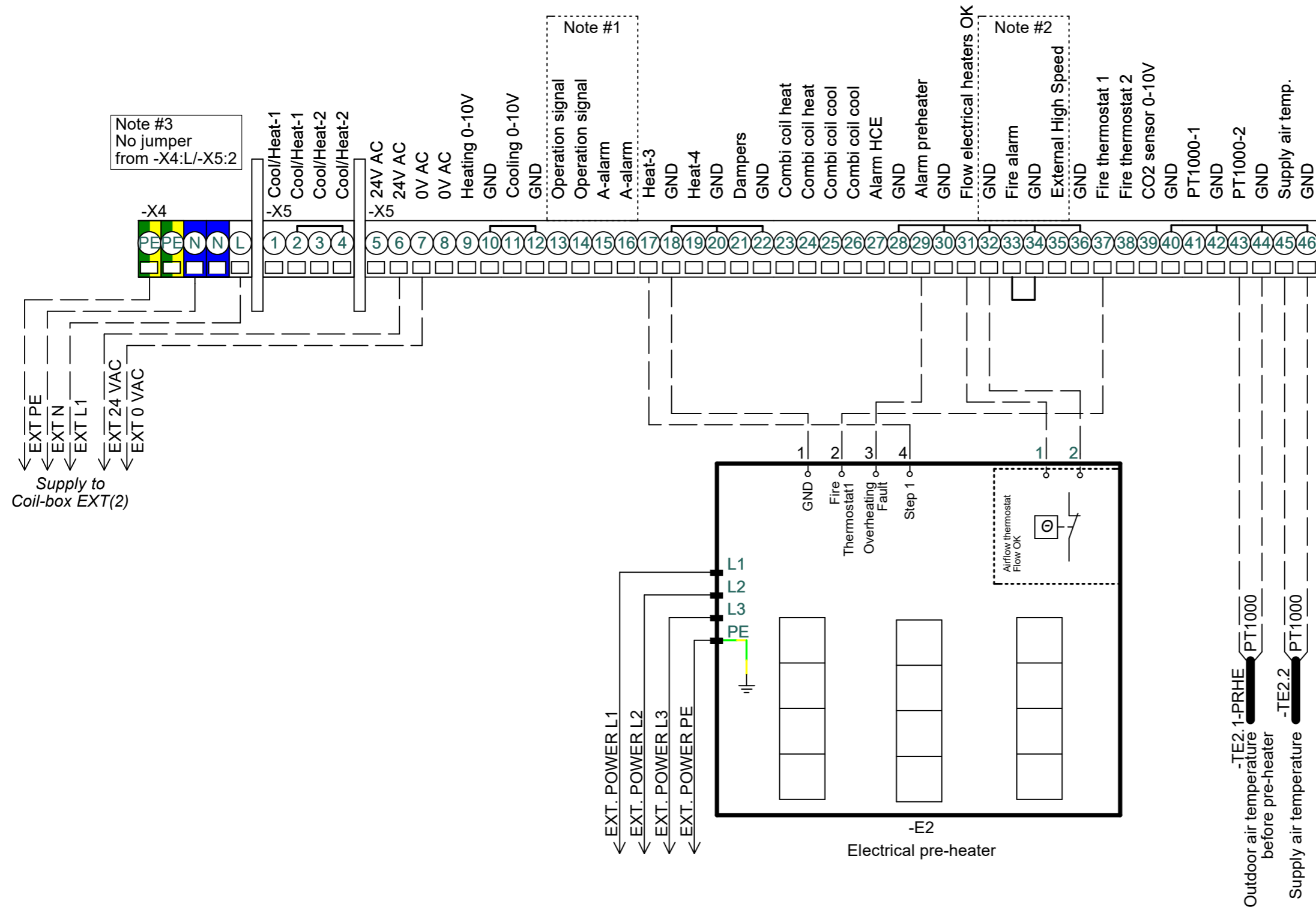

Note #1
 Default configuration.
 Can be changed to:
 - B-alarm output
 - Alarm reset
 - Summer operation
 - Summer night cooling

Note #2
 Default configuration.
 Can be changed to:
 - AHU STOP
 - Low speed
 - Medium speed
 - Frost alarm
 - External start
 - External reset alarms
 If used remove jumper

* Outdoor air temperature sensor must be mounted in the outside air duct, before the preheating coil.

* Supply air temperature sensor must be mounted in supply air duct after heating and cooling coils

* For connecting 3 heating/cooling coils an additional EXT Module is needed. This is addressed with Modbus ID #2. For connecting HCW and CCW please see next page

EXHAUSTO	Project:	CX3010 & CX3020	Start date:	24-08-2022	Constructor:	DKTSA	Page:	31			
	Drawing number:	0400101	Revision:	D	Page Title:	Configuration 11: Preheater+HCW+CCW	Revision date:	08-11-2023	Approved by:	DKLEG	Previous page:
					Replaces:	Rev. C	Scale:	1:1	Next page:	32	
					EC no.:		Format:		Pages in total:	39	

Configuration 11: Preheater + Water Heating Coil + Water Cooling Coil

Continued from page 31

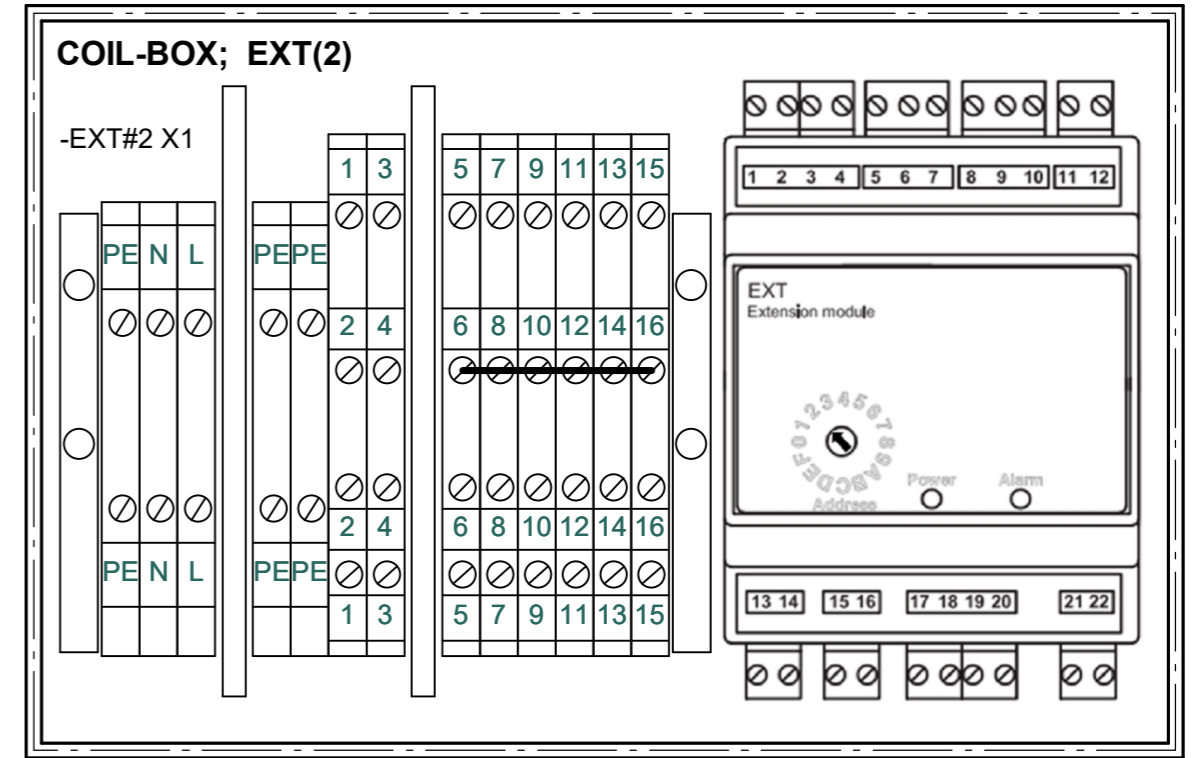
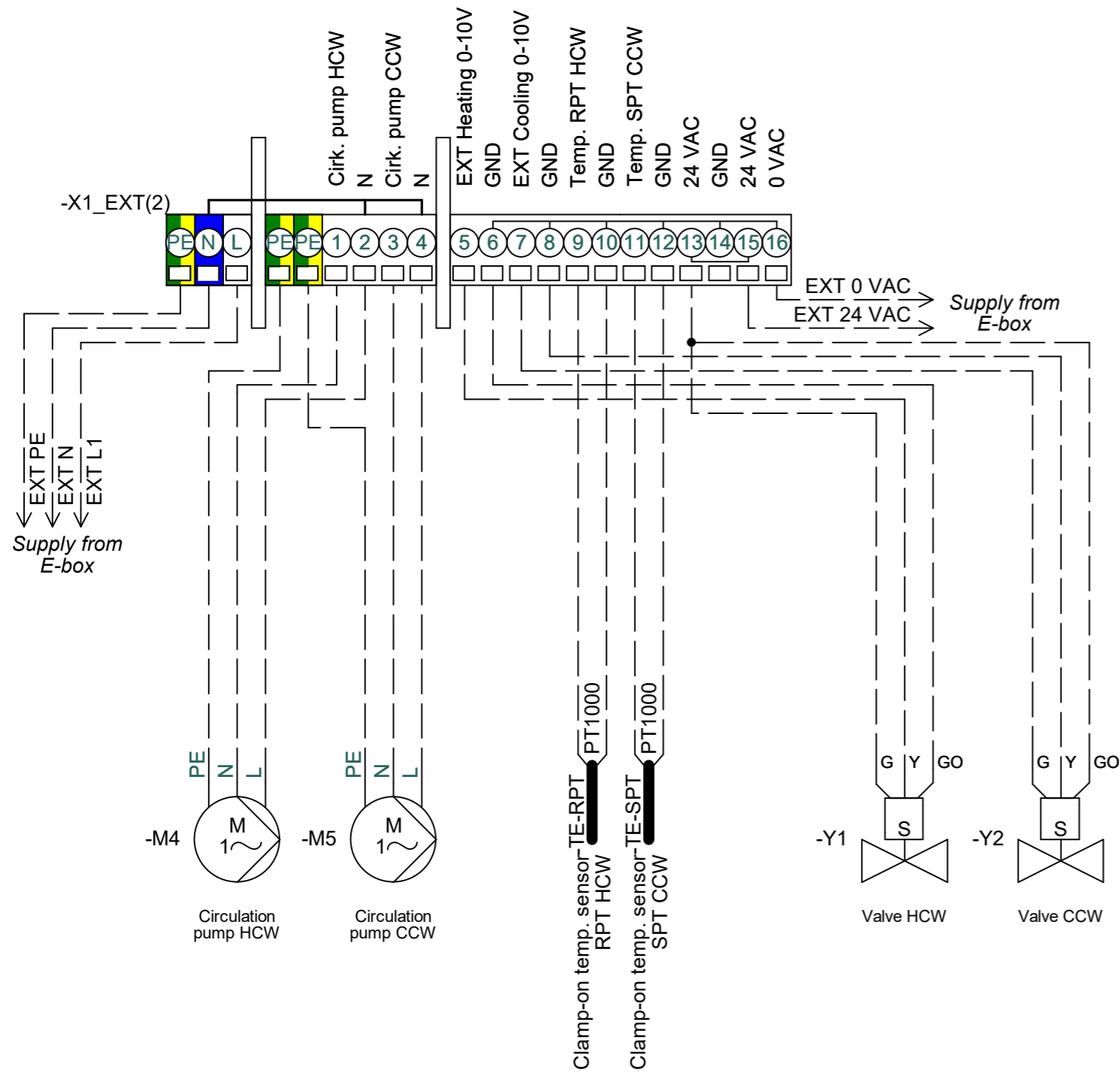

Note #1
Modbus connection to EXcon Master in E-box

EXHAUSTO

Project:
CX3010 & CX3020

Start date:	24-08-2022	Constructor:	DKTSA	Page:	32
Revision date:	08-11-2023	Approved by:	DKLEG	Previous page:	31
Replaces:	Rev. C	Scale:	1:1	Next page:	33
EC no.:		Format:		Pages in total:	39

Drawing number:
0400101

Revision:
D

Page Title:
Configuration 11: Preheater+HCW+CCW

Connections configuration 12: Electric Preheating Coil + Electric Postheating Coil + Water Cooling Coil

Continued on page 34

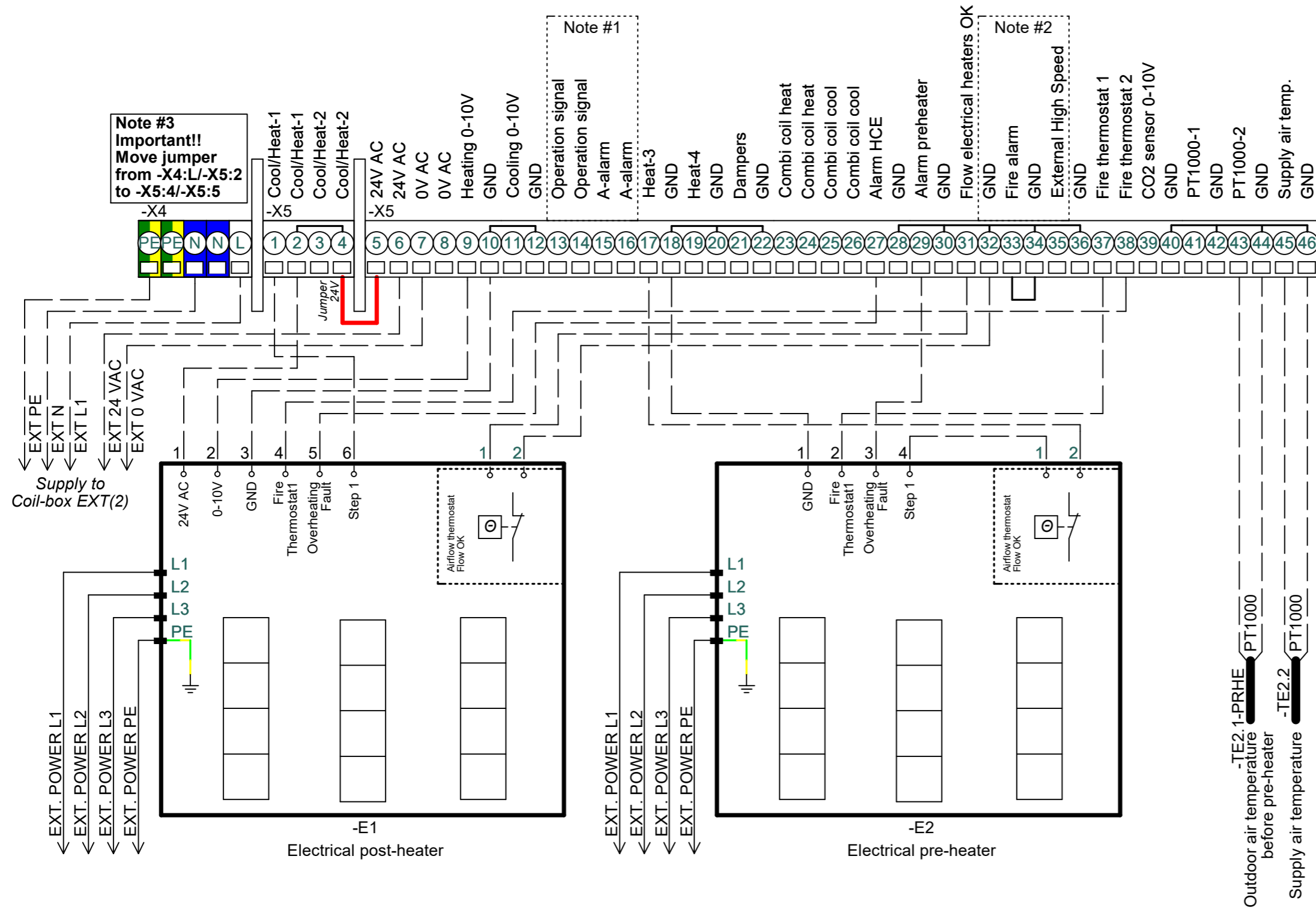

Note #1
 Default configuration.
 Can be changed to:
 - B-alarm output
 - Alarm reset
 - Summer operation
 - Summer night cooling

Note #2
 Default configuration.
 Can be changed to:
 - AHU STOP
 - Low speed
 - Medium speed
 - Frost alarm
 - External start
 - External reset alarms
 If used remove jumper

* Outdoor air temperature sensor must be mounted in the outside air duct, before the preheating coil.

* Supply air temperature sensor must be mounted in supply air duct after heating and cooling coils

* For connecting 3 heating/cooling coils an additional EXT Module is needed. This is addressed with Modbus ID #2. For connecting HCW and CCW please see next page

EXHAUSTO	Project:	CX3010 & CX3020	Start date:	24-08-2022	Constructor:	DKTSA	Page:	33			
	Drawing number:	0400101	Revision:	D	Page Title:	Configuration 12: Preheater+HCE+CCW	Revision date:	08-11-2023	Approved by:	DKLEG	Previous page:
			Replaces:	Rev. C	Scale:	1:1	Next page:	34			
			EC no.:		Format:		Pages in total:	39			

Connections configuration 12: Electric Preheating Coil + Electric Heating Coil + Water Cooling Coil

Continued from page 33

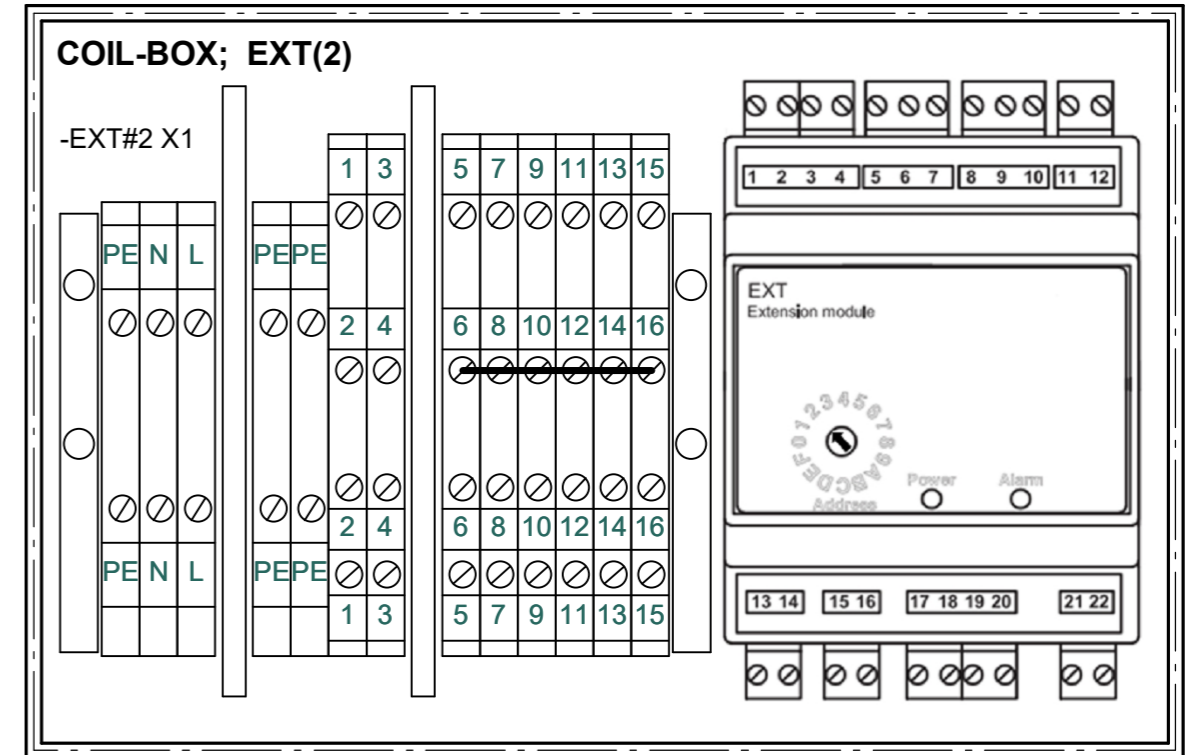
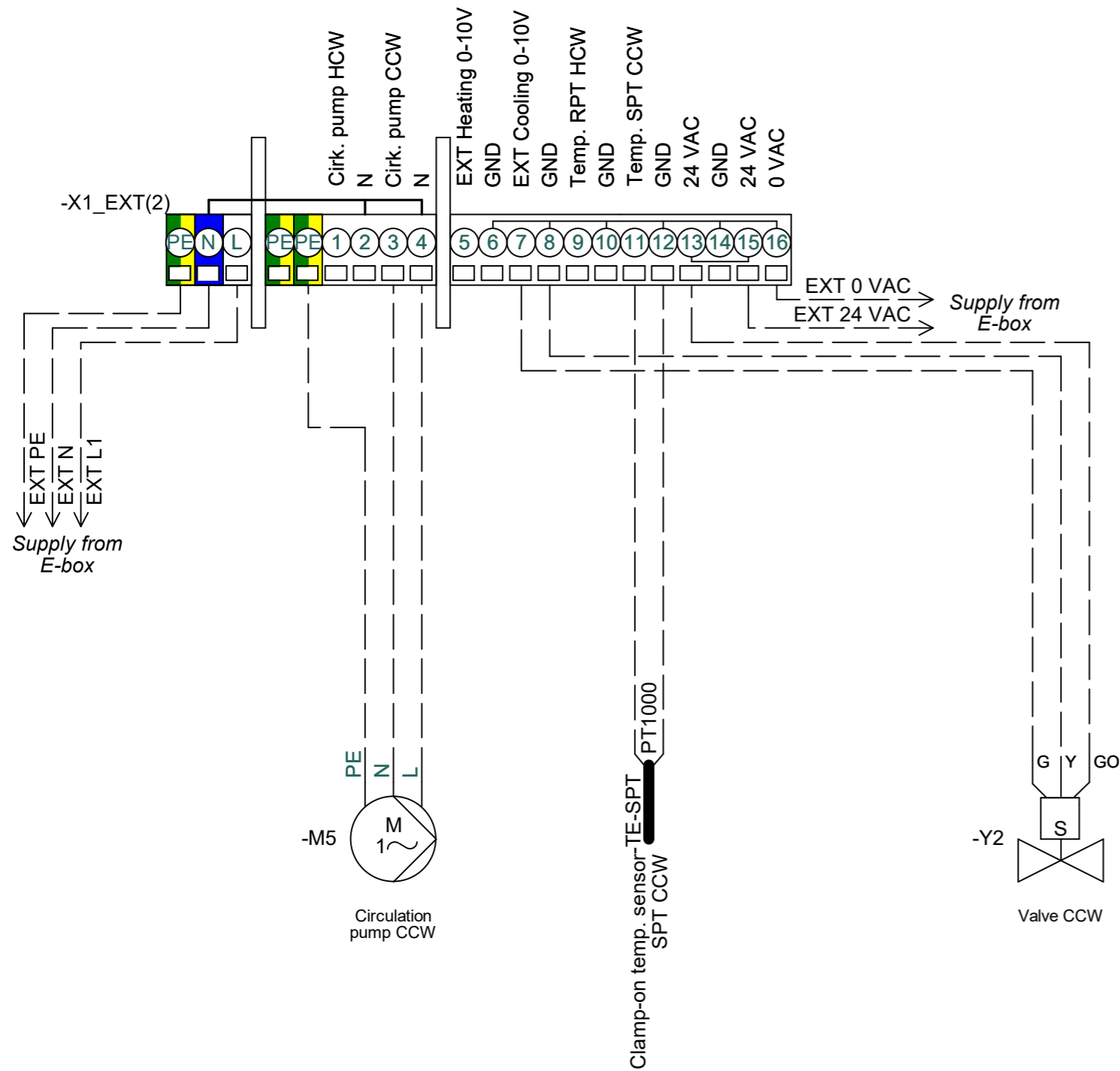

Note #1
Modbus connection to EXcon Master in E-box

EXHAUSTO

Project:
CX3010 & CX3020

Start date:	24-08-2022	Constructor:	DKTSA	Page:	34
Revision date:	08-11-2023	Approved by:	DKLEG	Previous page:	33
Replaces:	Rev. C	Scale:	1:1	Next page:	35
EC no.:		Format:		Pages in total:	39

Drawing number:
0400101

Revision:
D

Page Title:
Configuration 12: Preheater+HCE+CCW

Configuration 13: Change-Over CW (Combi-Coil)

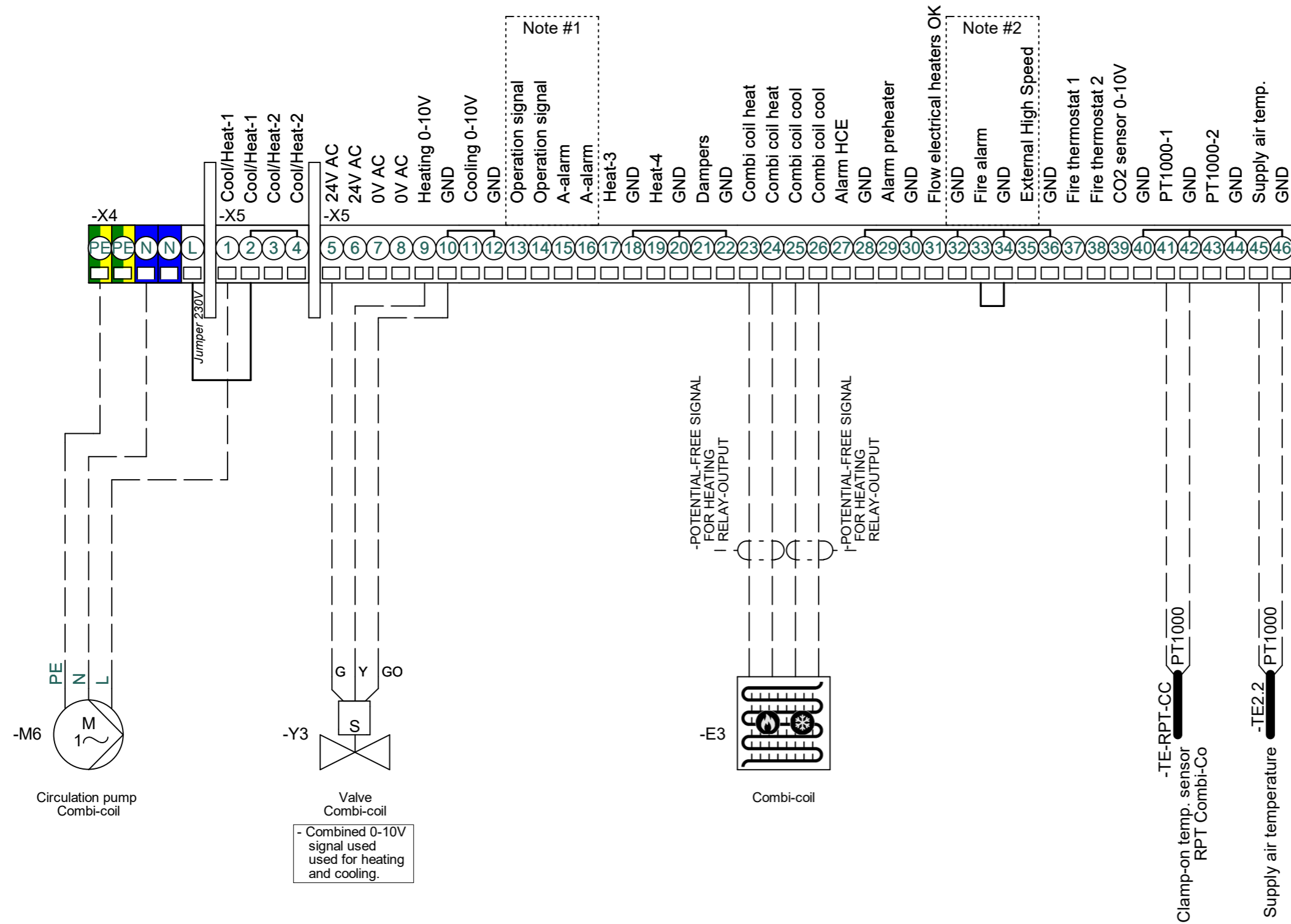

Note #1
 Default configuration.
 Can be changed to:
 - B-alarm output
 - Alarm reset
 - Summer operation
 - Summer night cooling

Note #2
 Default configuration.
 Can be changed to:
 - AHU STOP
 - Low speed
 - Medium speed
 - Frost alarm
 - External start
 - External reset alarms
 If used remove jumper

* Supply air temperature sensor must be mounted in supply air duct after heating and cooling coils

EXHAUSTO	Project:	CX3010 & CX3020	Start date:	24-08-2022	Constructor:	DKTSA	Page:	35			
	Drawing number:	0400101	Revision:	D	Page Title:	Configuration 13: C-O CW (Combi-Coil)	Revision date:	08-11-2023	Approved by:	DKLEG	Previous page:
			Replaces:	Rev. C	Scale:	1:1	Next page:	36			
			EC no.:		Format:		Pages in total:	39			

Connections configuration 14: Preheater + C-O CW (Combi-Coil)

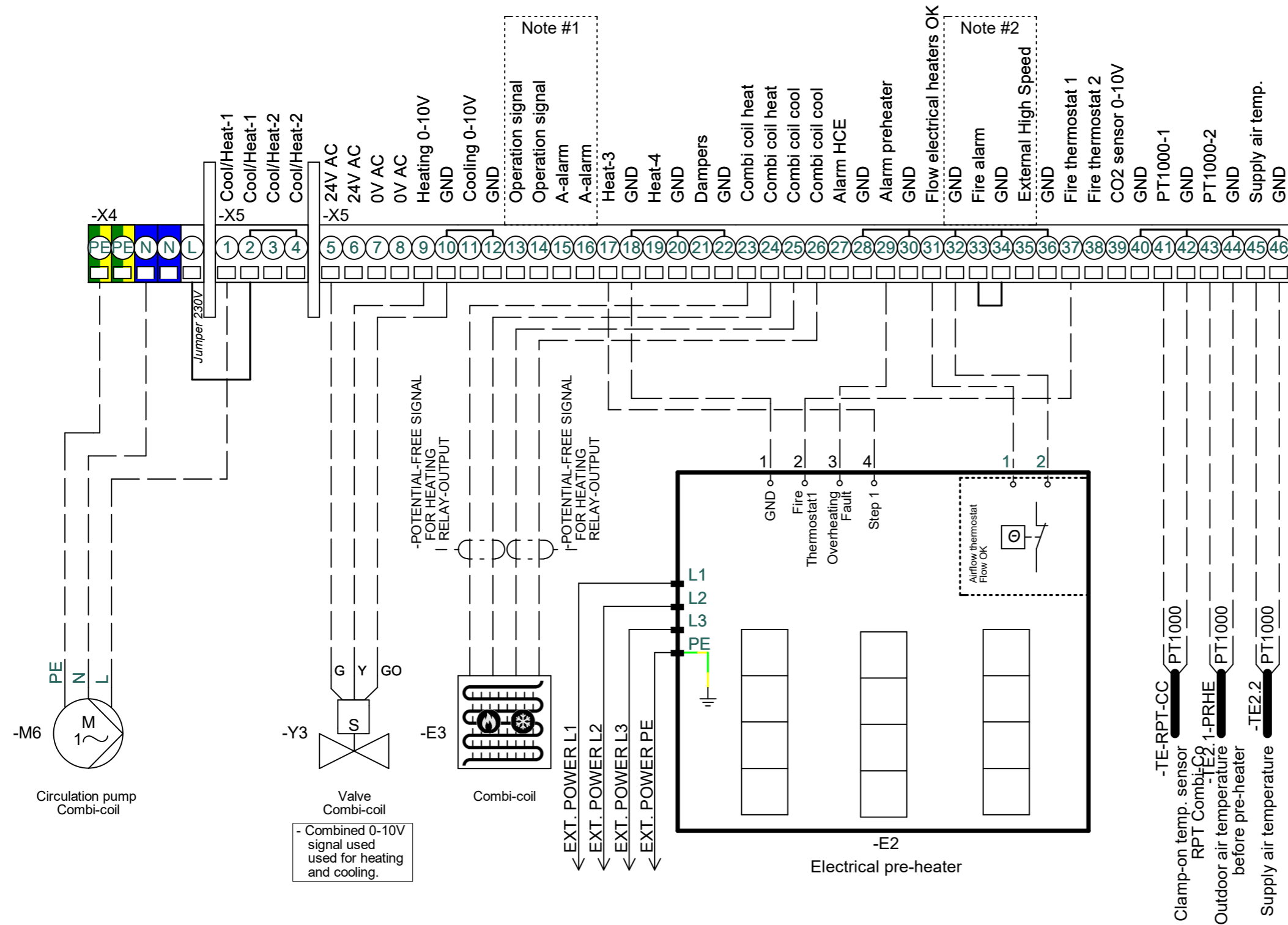

Note #1
 Default configuration.
 Can be changed to:
 - B-alarm output
 - Alarm reset
 - Summer operation
 - Summer night cooling

Note #2
 Default configuration.
 Can be changed to:
 - AHU STOP
 - Low speed
 - Medium speed
 - Frost alarm
 - External start
 - External reset alarms
 If used remove jumper

* Outdoor air temperature sensor must be mounted in the outside air duct, before the preheating coil.
 * Supply air temperature sensor must be mounted in supply air duct after heating and cooling coils

EXHAUSTO	Project:	CX3010 & CX3020	Start date:	24-08-2022	Constructor:	DKTSA	Page:	36	
	Drawing number:	0400101	Revision:	D	Revision date:	08-11-2023	Approved by:	DKLEG	Previous page:
Page Title:		Configuration 14: Preheater+Combi-Coil	Replaces:	Rev. C	Scale:	1:1	Next page:	37	
EC no.:			Format:		Pages in total:	39			

Optional accessories

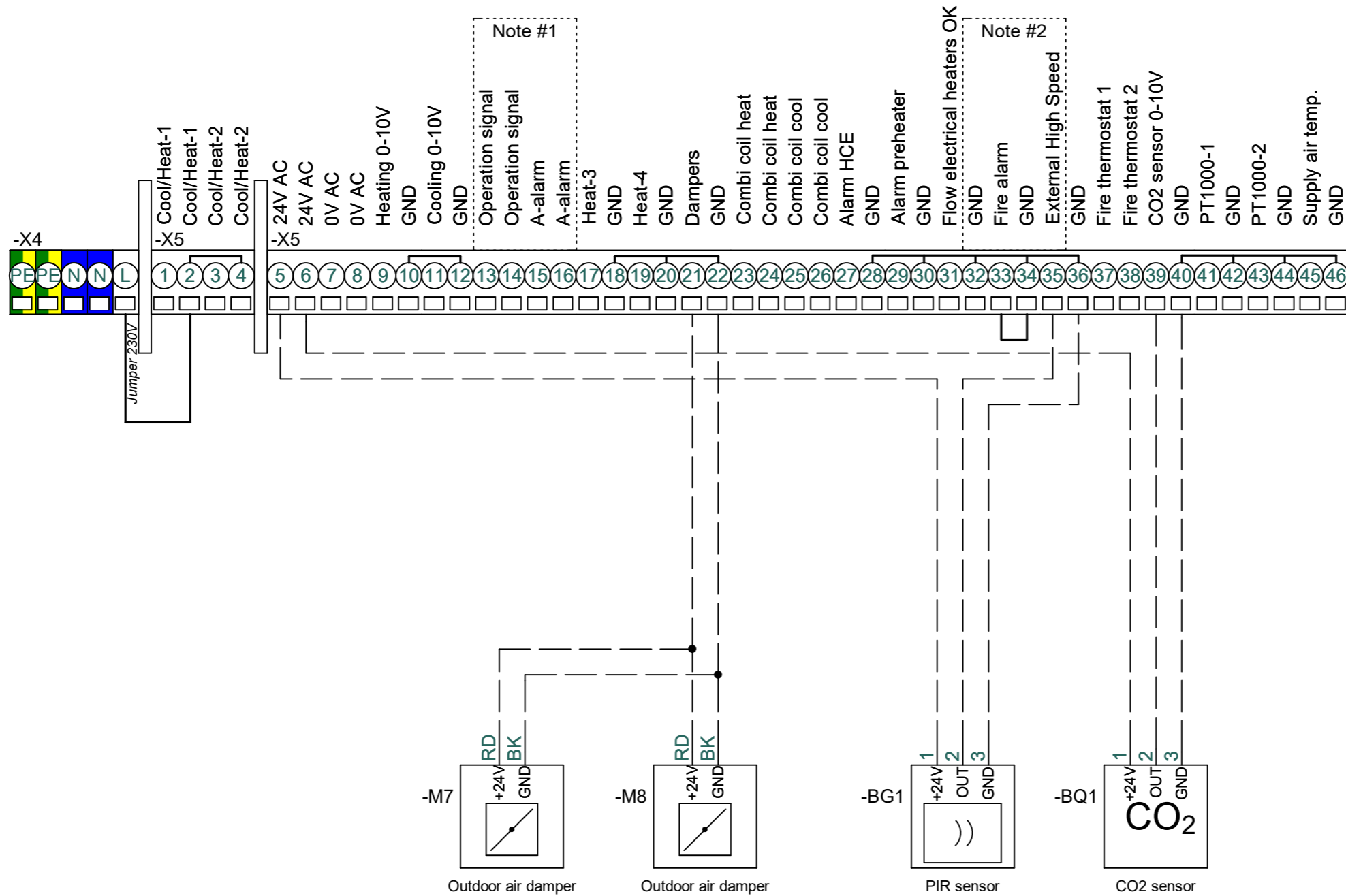

EXHAUSTO

Project: CX3010 & CX3020

Start date:	24-08-2022	Constructor:	DKTSA	Page:	37
Revision date:	08-11-2023	Approved by:	DKLEG	Previous page:	36
Replaces:	Rev. C	Scale:	1:1	Next page:	38
EC no.:		Format:		Pages in total:	39

Drawing number: 0400101

Revision: D

Page Title: Optional accessories

Optional accessories MODBUS

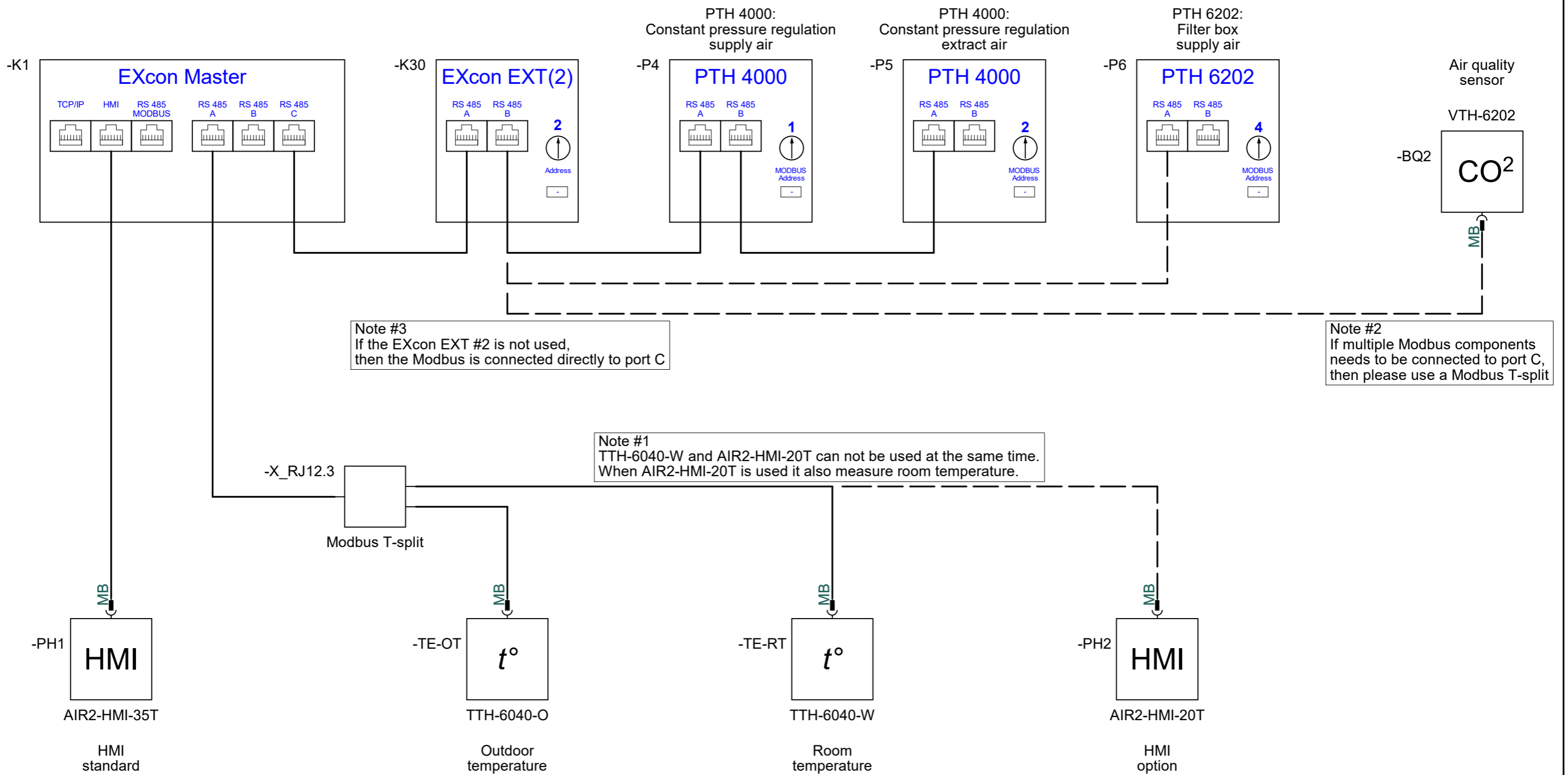

EXHAUSTO

Project:
CX3010 & CX3020

Start date:	24-08-2022	Constructor:	DKTSA	Page:	38
Revision date:	08-11-2023	Approved by:	DKLEG	Previous page:	37
Replaces:	Rev. C	Scale:	1:1	Next page:	40
EC no.:		Format:		Pages in total:	39

Drawing number:
0400101

Revision:
D

Page Title:
Optional accessories MODBUS

Electric heaters

EXHAUSTO	Project: CX3010 & CX3020	Start date: 24-08-2022	Constructor: DKTSA	Page: 40	
		Revision date: 08-11-2023	Approved by: DKLEG	Previous page: 38	
Drawing number: 0400101	Revision: D	Page Title: Electric heaters	Replaces: Rev. C	Scale: 1:1	Next page: 41
			EC no.:	Format:	Pages in total: 39

Component	Function	Position
+A4.1/-E1	Electric heater Step 1	/43.2
+A4.1/-F1	Main fuse	/43.1
+A4.1/-K1	Contactor HE 1	/43.7
+A4.1/-S2	Main switch pre-heater	/43.1
+A4.1/-T1	Fire thermostat 110°C	/43.5
+A4.1/-T2	Overheating thermostat 70°C	/43.5
+A4.1/-T3	Air flow thermostat Open@60°C/Reset@45°C	/43.9
+A4.1/-W1	Main power supply cable	/43.1
+A4.1/-X1	Terminals for Main supply	/43.1
+A4.1/-X3	Terminals for Control signals	/43.5
+A4.1/-X4	Terminals for Air flow OK	/43.9
+A4.2/-E1	Electric heater Step 1	/44.2
+A4.2/-F1	Main fuse	/44.1
+A4.2/-K1	Contactor HE 1	/44.7
+A4.2/-S3	Main switch heater	/44.1
+A4.2/-T1	Fire thermostat 110°C	/44.5
+A4.2/-T2	Overheating thermostat 70°C	/44.5
+A4.2/-T3	Air flow thermostat Open@60°C/Reset@45°C	/44.9
+A4.2/-TC1	Triac HE 1	/44.4
+A4.2/-W1	Main power supply cable	/44.1
+A4.2/-X1	Terminals for Main supply	/44.1
+A4.2/-X3	Terminals for Control signals	/44.4
+A4.2/-X4	Terminals for Air flow OK	/44.9

EXHAUSTO	Project: CX3010 & CX3020		Start date: 24-08-2022	Constructor: DKTSA	Page: 41
	Revision: D		Revision date: 08-11-2023	Approved by: DKLEG	Previous page: 40
Drawing number: 0400101	Page Title: Electric heaters component overview		Replaces: Rev. C	Scale: 1:1	Next page: 42
			EC no.:	Format:	Pages in total: 39

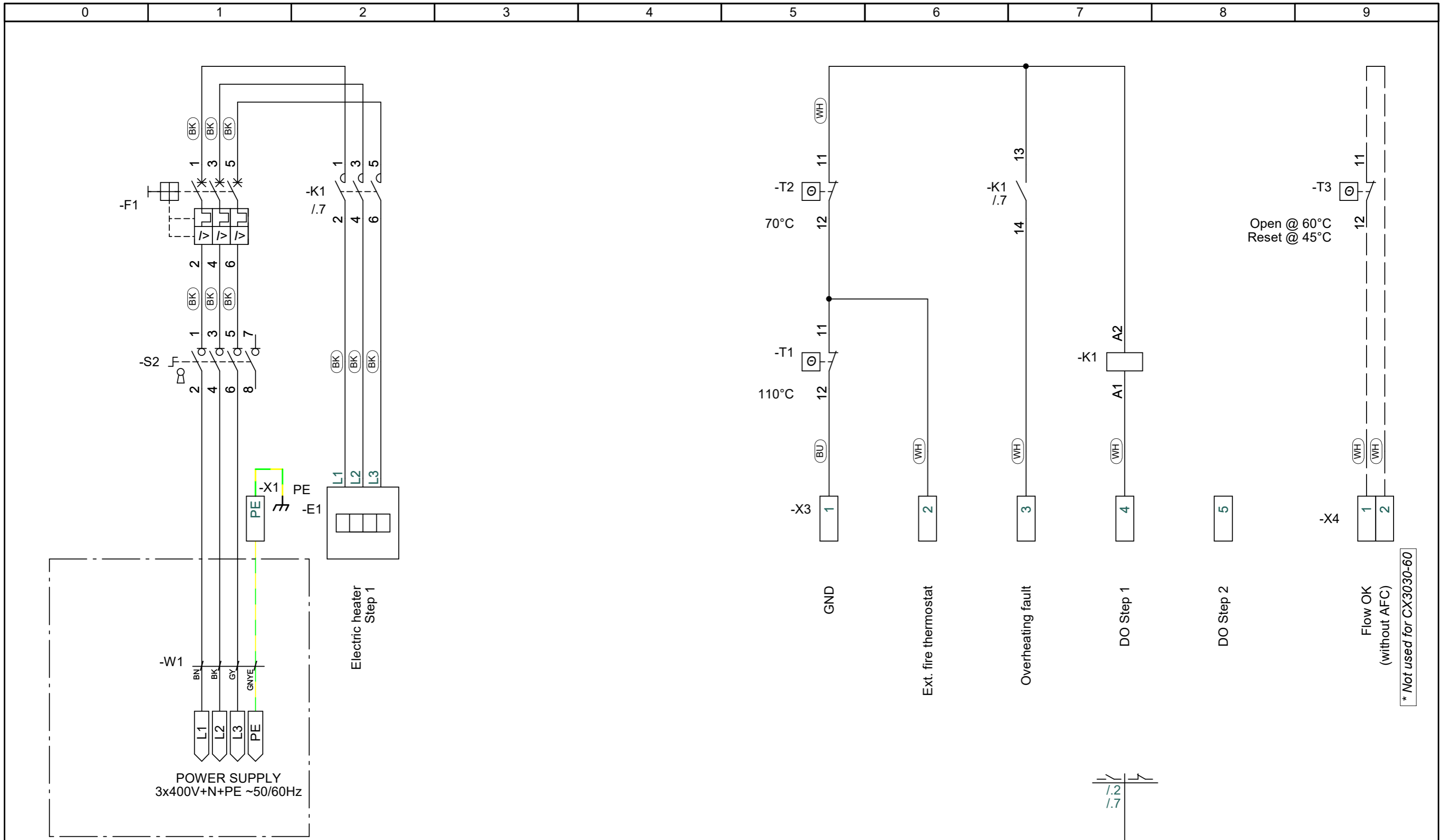

EXHAUSTO	Project:	CX3010 & CX3020		Start date:	24-08-2022	Constructor:	DKTSA	Page:	42
	Drawing number:	Revision:	Page Title:	Replaces:	Rev. C	Approved by:	DKLEG	Previous page:	41
0400101	D	Electric pre-heater Step 1		EC no.:		Scale:	1:1	Next page:	43
						Format:		Pages in total:	39

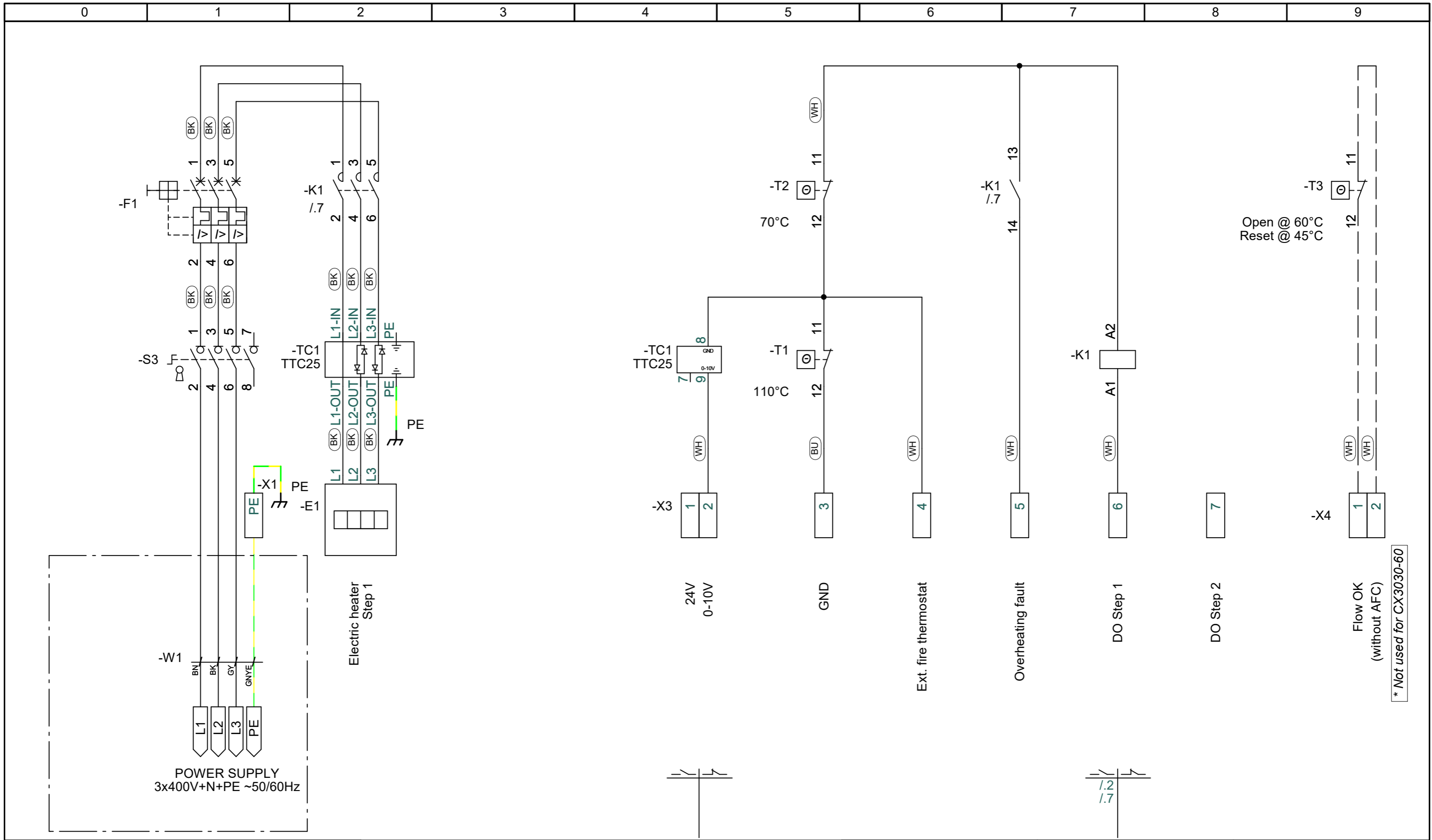

EXHAUSTO	Project:	CX3010 & CX3020	Start date:	24-08-2022	Constructor:	DKTSA	Page:	43	
	Drawing number:	0400101	Revision:	D	Revision date:	08-11-2023	Approved by:	DKLEG	Previous page:
Page Title:		Electric heater Step 1	Replaces:	Rev. C	Scale:	1:1	Next page:	44	
			EC no.:		Format:		Pages in total:	39	

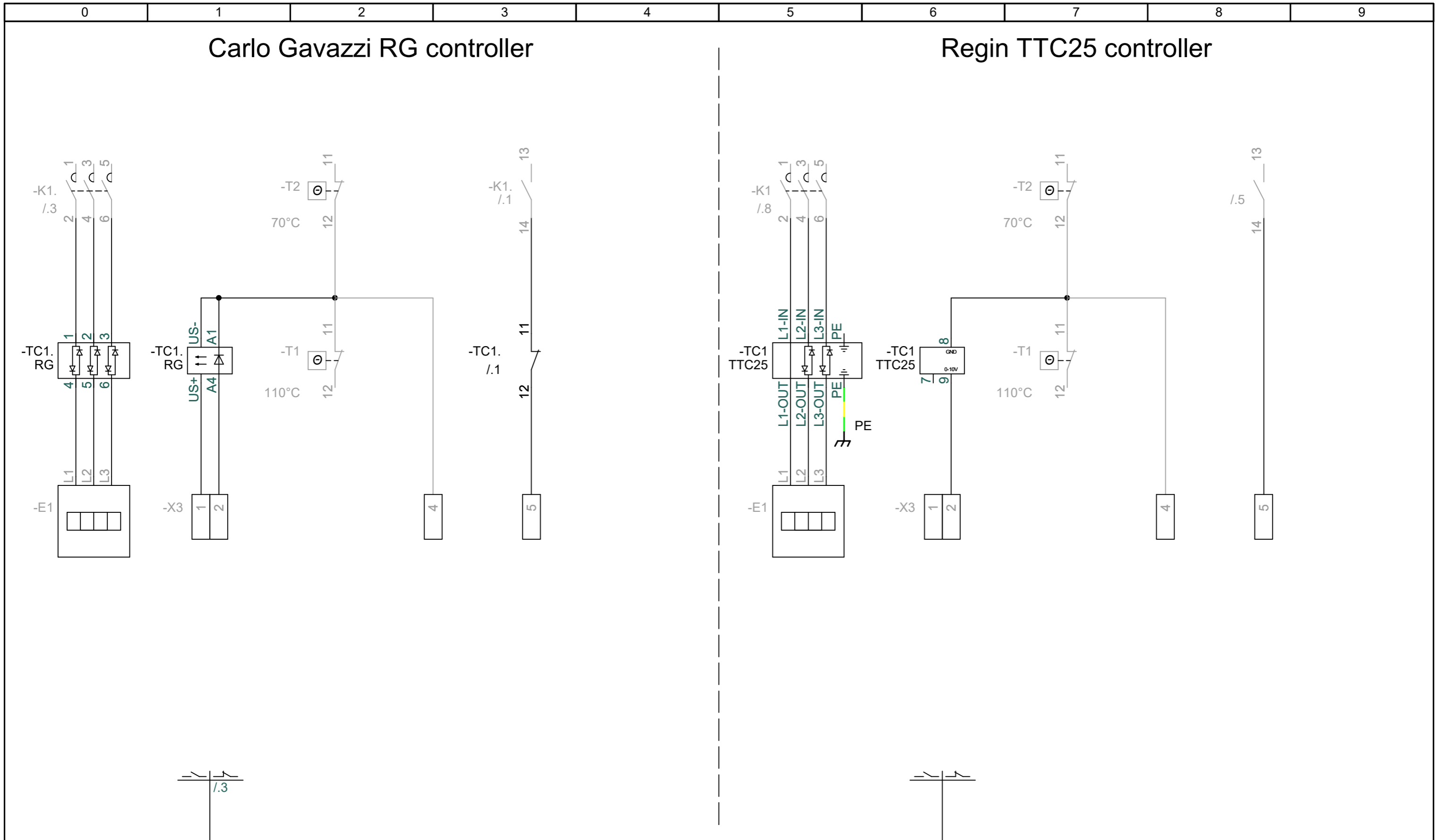

EXHAUSTO

Project: CX3010 & CX3020

Start date:	24-08-2022	Constructor:	DKTSA	Page:	44
Revision date:	08-11-2023	Approved by:	DKLEG	Previous page:	43

Drawing number: 0400101
Revision: D

Page Title: Carlo Gavazzi RG vs Regin TTC25

Replaces:	Rev. C	Scale:	1:1	Next page:	
EC no.:		Format:		Pages in total:	39