

GB

CX3030-CX3040 Wiring diagram

EXcon-automatic

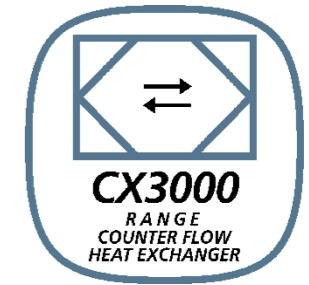

CX3030 & CX3040

0400102

230VAC - Pressure deicing
CX3030: 1400 m³/h
CX3040: 2000 m³/h

EXHAUSTO	Project: CX3030 & CX3040	Start date: 24-08-2022	Constructor: DKTSA	Page: 1	
		Revision date: 08-11-2023	Approved by: DKLEG	Previous page: 0	
Drawing number: 0400102	Revision: D	Page Title: Project information	Replaces: Rev. C	Scale: 1:1	Next page: 2
			EC no.:	Format:	Pages in total: 43

Page	Title	Page remarks	Last edit
1	Project information		22-12-2022
4	Standards		26-05-2023
5	Component overview		26-05-2023
10	E-box lay-out		26-05-2023
11	Terminals		10-05-2023
12	Main power		10-05-2023
13	Main power		09-05-2023
14	Terminal wiring EXcon Master		22-12-2022
15	Terminal wiring EXT module (1)		22-12-2022
16	Terminal wiring EXT module (2)		22-12-2022
17	PTH connections		22-12-2022
20	Configurations		22-12-2022
21	Configuration 1: No coils		22-12-2022
22	Configuration 2: HCW		22-12-2022
23	Configuration 3: HCE		22-12-2022
24	Configuration 4: CCW		22-12-2022
25	Configuration 5: Preheater		22-12-2022
26	Configuration 6: HCW+CCW		22-12-2022
27	Configuration 7: HCE+CCW		22-12-2022
28	Configuration 8: Preheater+HCW		22-12-2022
29	Configuration 9: Preheater+CCW		22-12-2022
30	Configuration 10: Preheater+HCE		22-12-2022
31	Configuration 11: Preheater+HCW+CCW		22-12-2022
32	Configuration 11: Preheater+HCW+CCW		22-12-2022
33	Configuration 12: Preheater+HCE+CCW		22-12-2022
34	Configuration 12: Preheater+HCE+CCW		22-12-2022
35	Configuration 13: C-O CW (Combi-Coil)		22-12-2022
36	Configuration 14: Preheater+Combi-Coil		22-12-2022
37	Optional accessories		16-06-2023

EXHAUSTO

Project:
CX3030 & CX3040

Start date:	24-08-2022	Constructor:	DKTSA	Page:	2
Revision date:	08-11-2023	Approved by:	DKLEG	Previous page:	1
Replaces:	Rev. C	Scale:	1:1	Next page:	3
EC no.:		Format:		Pages in total:	43

Drawing number:
0400102

Revision:
D

Page Title:
Table of Contents

Page	Title	Page remarks	Last edit
38	Optional accessories MODBUS		08-11-2023
40	Electric heaters		22-12-2022
41	Electric heaters component overview		09-05-2023
43	Electric pre-heater Step 1		08-11-2023
44	Electric heater Step 1		08-11-2023
45	Electric pre-heater Step 1 & 2		08-11-2023
46	Electric heater Step 1 & 2		08-11-2023
47	Carlo Gavazzi RG vs Regin TTC25	Difference in wiring of Triac controllers	08-11-2023

Identification of wires by colour

400/230VAC Main current:

Phase: Black
 Neutral: Blue
 Earth: Green/Yellow

230/24VAC Pilot current:

Phase: Red
 Neutral: Blue
 Earth: Green/Yellow

24VDC Pilot current:

Positive (+): Red
 Negative (-): White

Signals:

Temperature: White
 Dry contact: White
 Analog: White
 Digital: White

Unknown potential:

All: Orange

Abbreviations of colours (according to IEC 60757)

Black	BK
Brown	BN
Red	RD
Orange	OG
Yellow	YE
Green	GN
Blue	BU
Light Blue	BU
Violet	VT
Gray	GY
White	WH
Pink	PK
Gold	GD
Turquoise	TQ
Silver	SR
Green/Yellow	GNYE

Other standards

Labelling of cables and cores (according to IEC 62491): Method CR

Method	Description
0	No labelling
A	Use of designated cables or cores
R	Identification labelling by means of reference designation (including cable number)
CL	Local-end connection labelling
CR	Remote-end connection labelling
CB	Both-end connection labelling
S	Signal labelling

EXHAUSTO

Project:
CX3030 & CX3040

Start date:	24-08-2022	Constructor:	DKTSA	Page:	4
Revision date:	08-11-2023	Approved by:	DKLEG	Previous page:	3
Replaces:	Rev. C	Scale:	1:1	Next page:	5
EC no.:		Format:		Pages in total:	43

Drawing number:
0400102

Revision:
D

Page Title:
Standards

Component	Function	Position
+A1	Control system panel	/10.5
+A2	CX-unit	/10.1
+A3	Coil-box	/10.2
+A4	Customer accessory	/10.2
-BG1	PIR sensor	/37.5
-BQ1	CO2 sensor	/37.6
-BQ2	Air quality sensor	/38.9
-E1	Electrical post-heater	/23.4
-E2	Electrical pre-heater	/25.4
-E3	Combi-coil	/35.4
-F1	Fuse for Main supply	/12.3
-F2	Fuse for EXcon Master	/13.3
-F3	Fuse for external connections	/13.3
-F4	Fuse for Supply fan	/12.5
-F5	Fuse for Exhaust fan	/12.7
-K1	EXcon Master	/14.2
-K27	Extension modul (1)	/15.2
-K30	Extension modul (2)	/16.2
-M1	Supply fan	/12.5
-M2	Exhaust fan	/12.7
-M3	Bypass motor	/14.8
-M4	Circulation pump HCW	/22.0
-M5	Circulation pump CCW	/24.1
-M6	Circulation pump Combi-coil	/35.0
-P1	PTH: Measures pressure over the heat exchanger	/17.2
-P2	DUAL PTH: Supply airflow and extract filter pressure	/17.4
-P3	DUAL PTH: Extract airflow and outdoorfilter pressure	/17.7
-P4	PTH 4000: Constant pressure regulation supply air	/38.5
-P5	PTH 4000: Constant pressure regulation extract air	/38.7

EXHAUSTO

Project:
CX3030 & CX3040

Start date:	24-08-2022	Constructor:	DKTSA	Page:	5
Revision date:	08-11-2023	Approved by:	DKLEG	Previous page:	4
Replaces:	Rev. C	Scale:	1:1	Next page:	6
EC no.:		Format:		Pages in total:	43

Drawing number:
0400102

Revision:
D

Page Title:
Component overview

Component	Function	Position
-PH1	HMI standard	/38.1
-PH2	HMI option	/38.7
-S1	Main switch	/12.1
-T1	Power supply 230VAC/2x24VDC	/13.3
-TE1.1	Extract air temperature	/17.5
-TE1.2	Exhaust air temperature	/17.8
-TE2.1	Outdoor air temperature	/17.8
-TE2.1-PRE	Outdoor air temperature	/25.7
-TE2.2	Supply air temperature	/21.7
-TE-OT	Outdoor temperature	/38.3
-TE-RPT	Clamp-on temp. sensor RPT HCW	/22.6
-TE-RPT-CC	Clamp-on temp. sensor RPT Combi-Co	/35.6
-TE-RT	Room temperature	/38.5
-TE-SPT	Clamp-on temp. sensor SPT CCW	/24.7
-W1	Main power supply cable	/12.1
-X1	Terminals for Main supply	/12.1
-X1_EXT(2)	Terminals for Coil-box	/16.2
-X2	Terminals for fans	/12.5
-X3	Terminal for fuses 24V	/13.3
-X4	Terminals for Circulation pumps	/13.8
-X5	Terminals for External customer connections	/15.4
-X_BP	Plug bypass motor	/14.8
-X_FAN EX	Plug Exhaust fan	/12.7
-X_FAN SU	Plug Supply fan	/12.5
-X_RJ12.1	Modbus T-split	/14.8
-X_RJ12.2	Modbus T-split	/17.3
-X_RJ12.3	Modbus T-split	/38.2
-Y1	Valve HCW	/22.2
-Y2	Valve CCW	/24.2

EXHAUSTO

Project:
CX3030 & CX3040

Start date: 24-08-2022 Constructor: DKTSA Page: 6

Revision date: 08-11-2023 Approved by: DKLEG Previous page: 5

Drawing number:
0400102

Revision:
D

Page Title:
Component overview

Replaces: Rev. C Scale: 1:1 Next page: 7

EC no.: Format: Pages in total: 43

Component	Function	Position
-Y3	Valve Combi-coil	/35.2

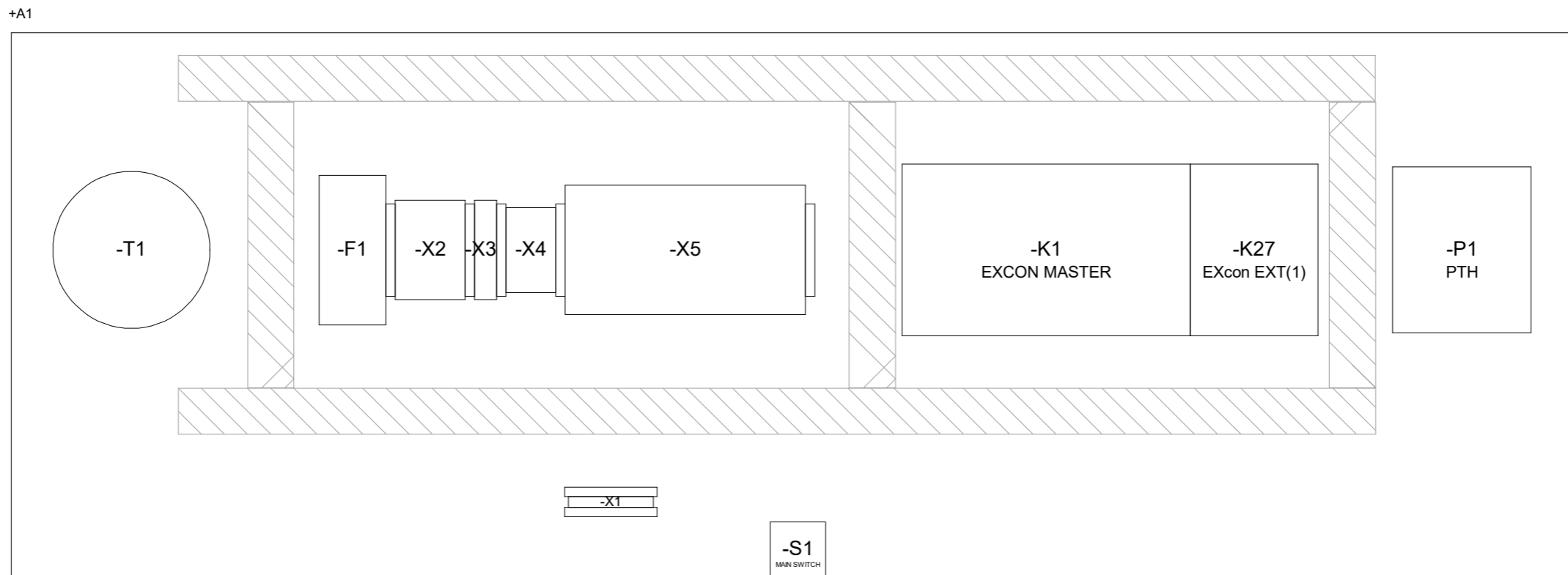

EXHAUSTO

Project:
CX3030 & CX3040

Start date: 24-08-2022 Constructor: DKTSA Page: 10

Revision date: 08-11-2023 Approved by: DKLEG Previous page: 7

Drawing number:
0400102

Revision:
D

Page Title:
E-box lay-out

Replaces: Rev. C Scale: 1:3 Next page: 11

EC no.: Format: Pages in total: 43

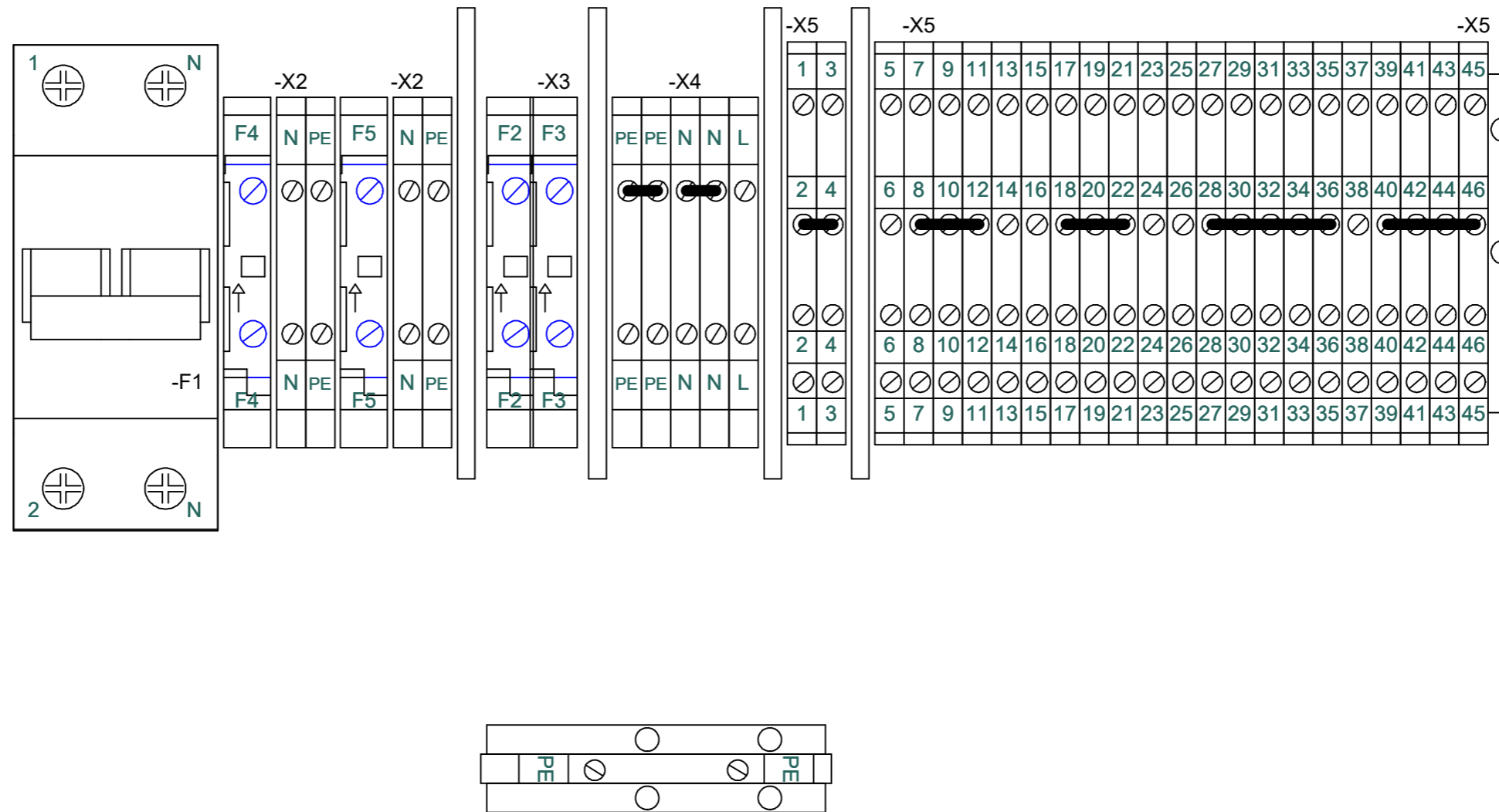

EXHAUSTO

Project:
CX3030 & CX3040

Start date:	24-08-2022	Constructor:	DKTSA	Page:	11
Revision date:	08-11-2023	Approved by:	DKLEG	Previous page:	10
Replaces:	Rev. C	Scale:	1:1	Next page:	12
EC no.:		Format:		Pages in total:	43

Drawing number:
0400102

Revision:
D

Page Title:
Terminals

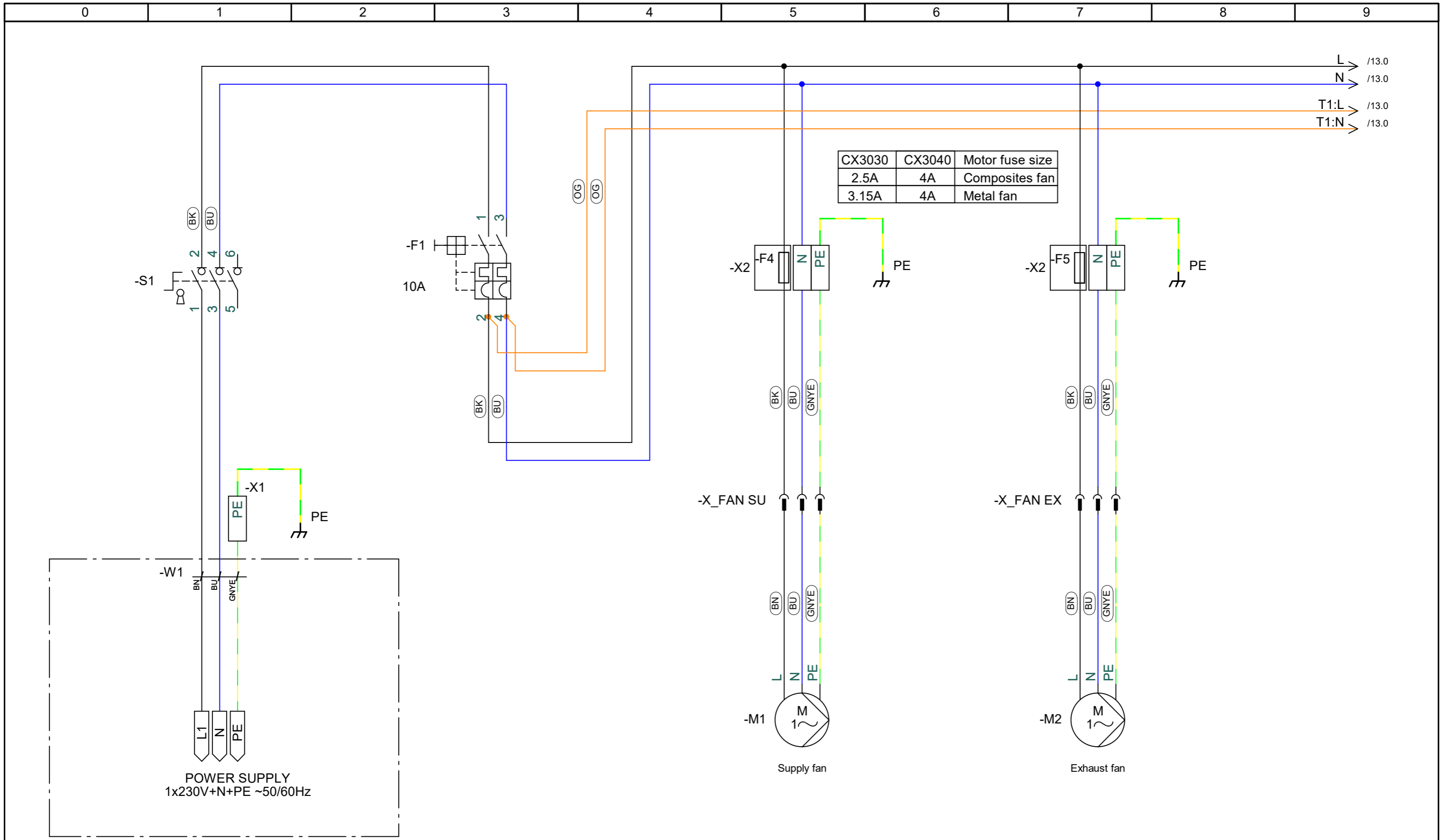

EXHAUSTO

Project:
CX3030 & CX3040

Start date:	24-08-2022	Constructor:	DKTSA	Page:	12
Revision date:	08-11-2023	Approved by:	DKLEG	Previous page:	11
Replaces:	Rev. C	Scale:	1:1	Next page:	13
EC no.:		Format:		Pages in total:	43

Drawing number:
0400102

Revision:
D

Page Title:
Main power

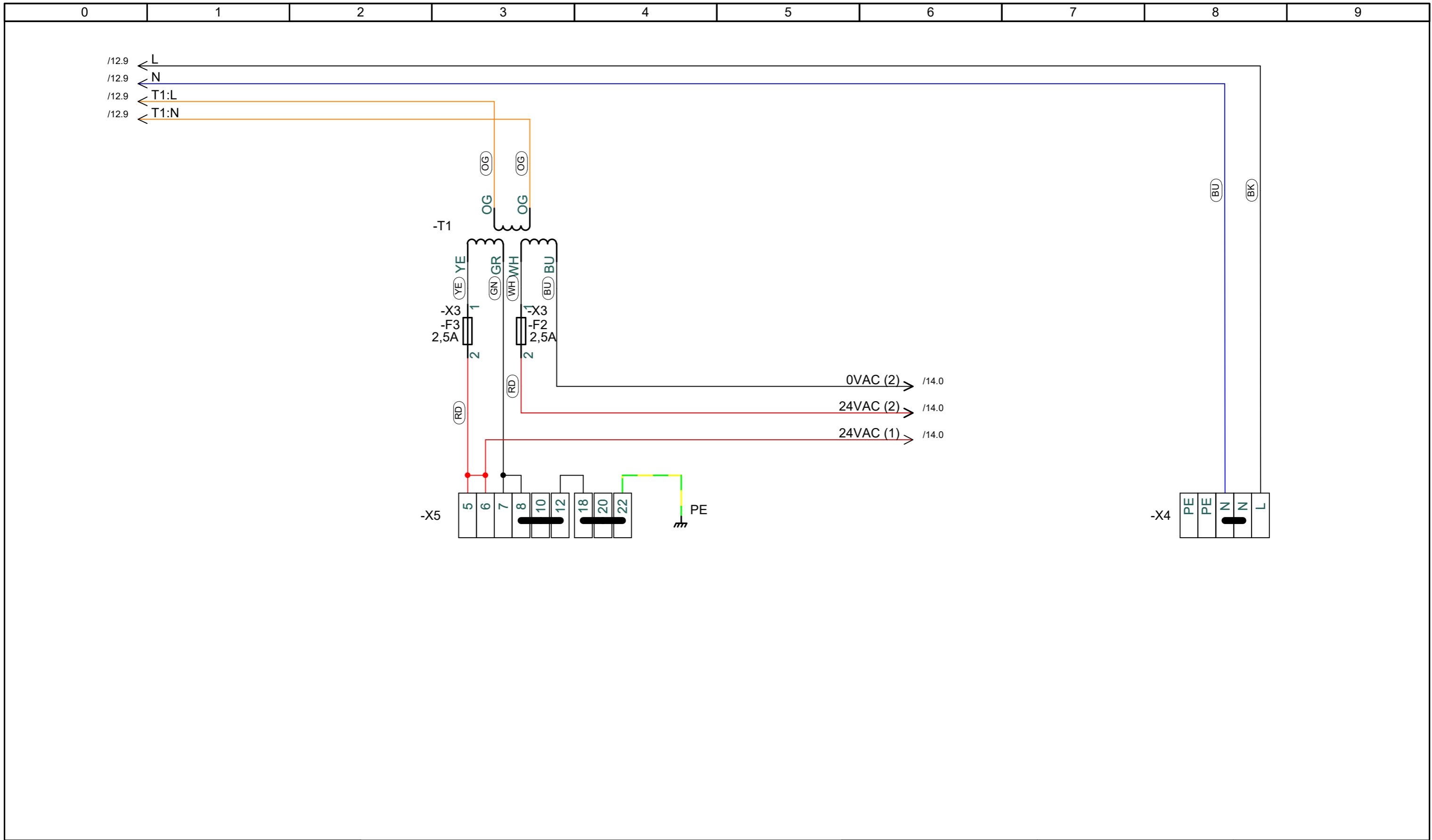

EXHAUSTO	Project:	CX3030 & CX3040	Start date:	24-08-2022	Constructor:	DKTSA	Page:	13			
	Drawing number:	0400102	Revision:	D	Page Title:	Main power	Revision date:	08-11-2023	Approved by:	DKLEG	Previous page:
					Replaces:	Rev. C	Scale:	1:1	Next page:	14	
					EC no.:		Format:		Pages in total:	43	

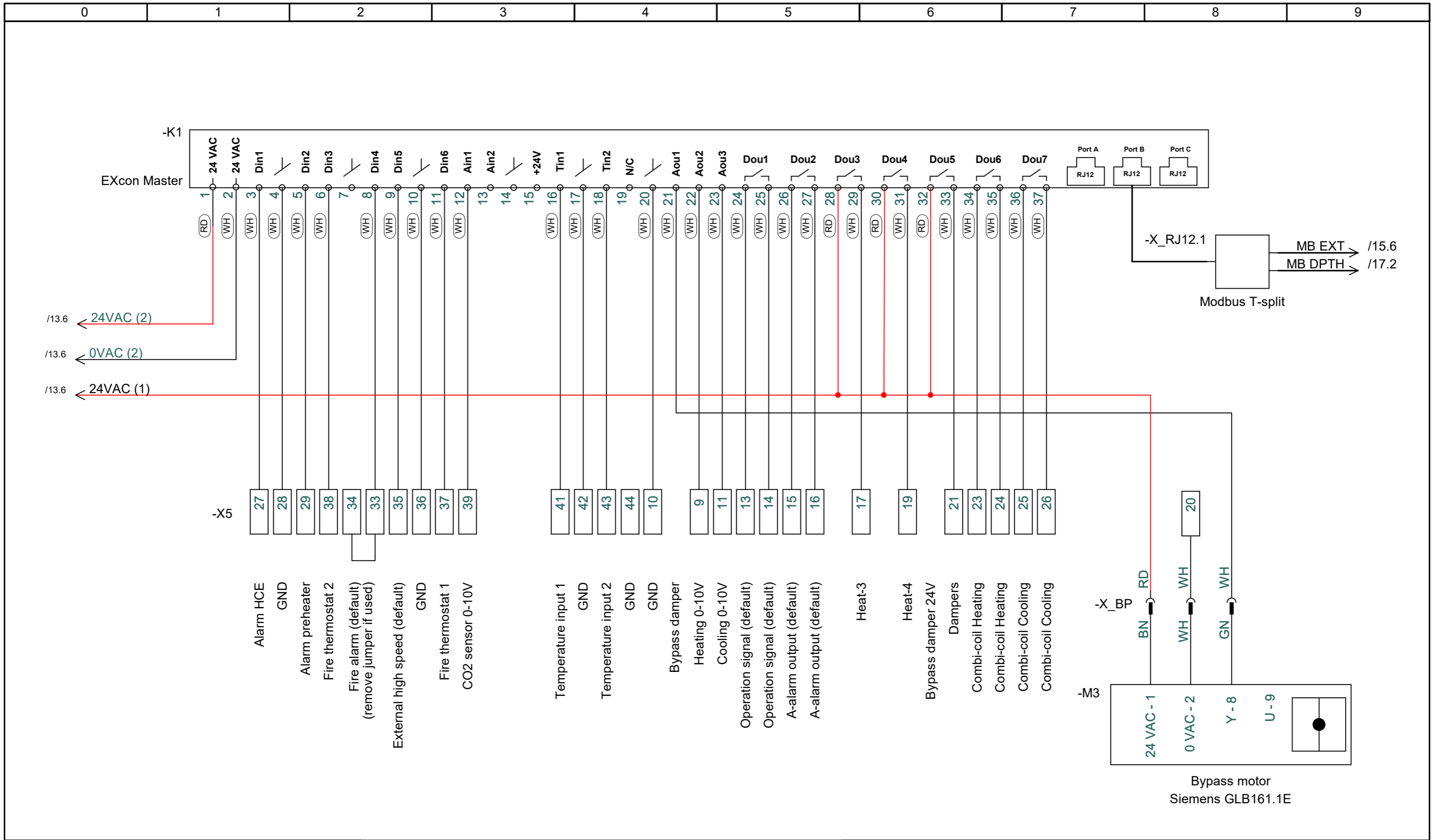

EXHAUSTO	Project:	CX3030 & CX3040	Start date:	24-08-2022	Constructor:	DKTSA	Page:	14			
	Drawing number:	0400102	Revision:	D	Page Title:	Terminal wiring EXcon Master	Revision date:	08-11-2023	Approved by:	DKLEG	Previous page:
					Replaces:	Rev. C	Scale:	1:1	Next page:	15	
					EC no.:		Format:		Pages in total:	43	

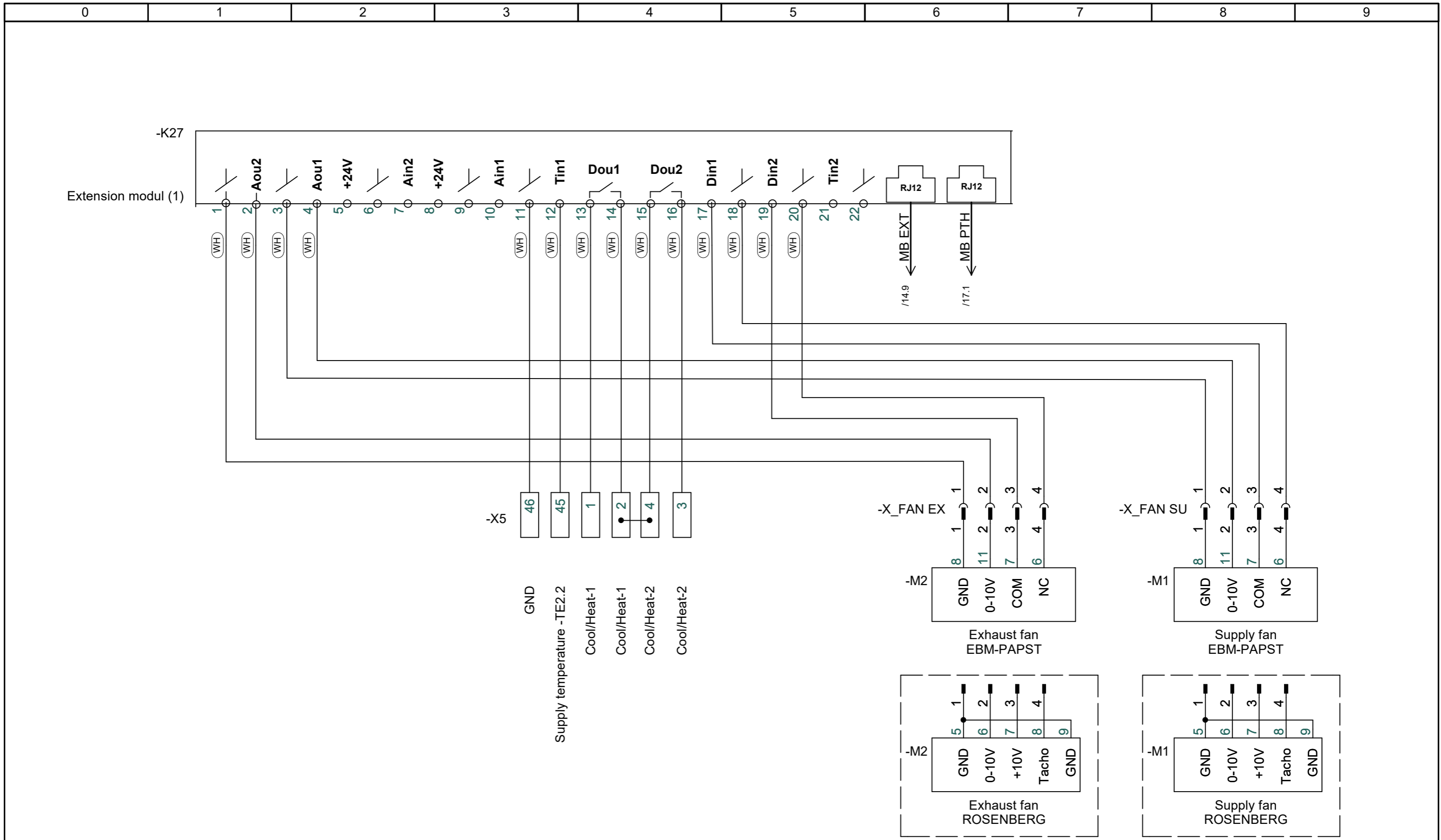

EXHAUSTO	Project:	CX3030 & CX3040	Start date:	24-08-2022	Constructor:	DKTSA	Page:	15	
	Drawing number:	0400102	Revision:	D	Revision date:	08-11-2023	Approved by:	DKLEG	Previous page:
Page Title:		Terminal wiring EXT module (1)	Replaces:	Rev. C	Scale:	1:1	Next page:	16	
			EC no.:		Format:		Pages in total:	43	

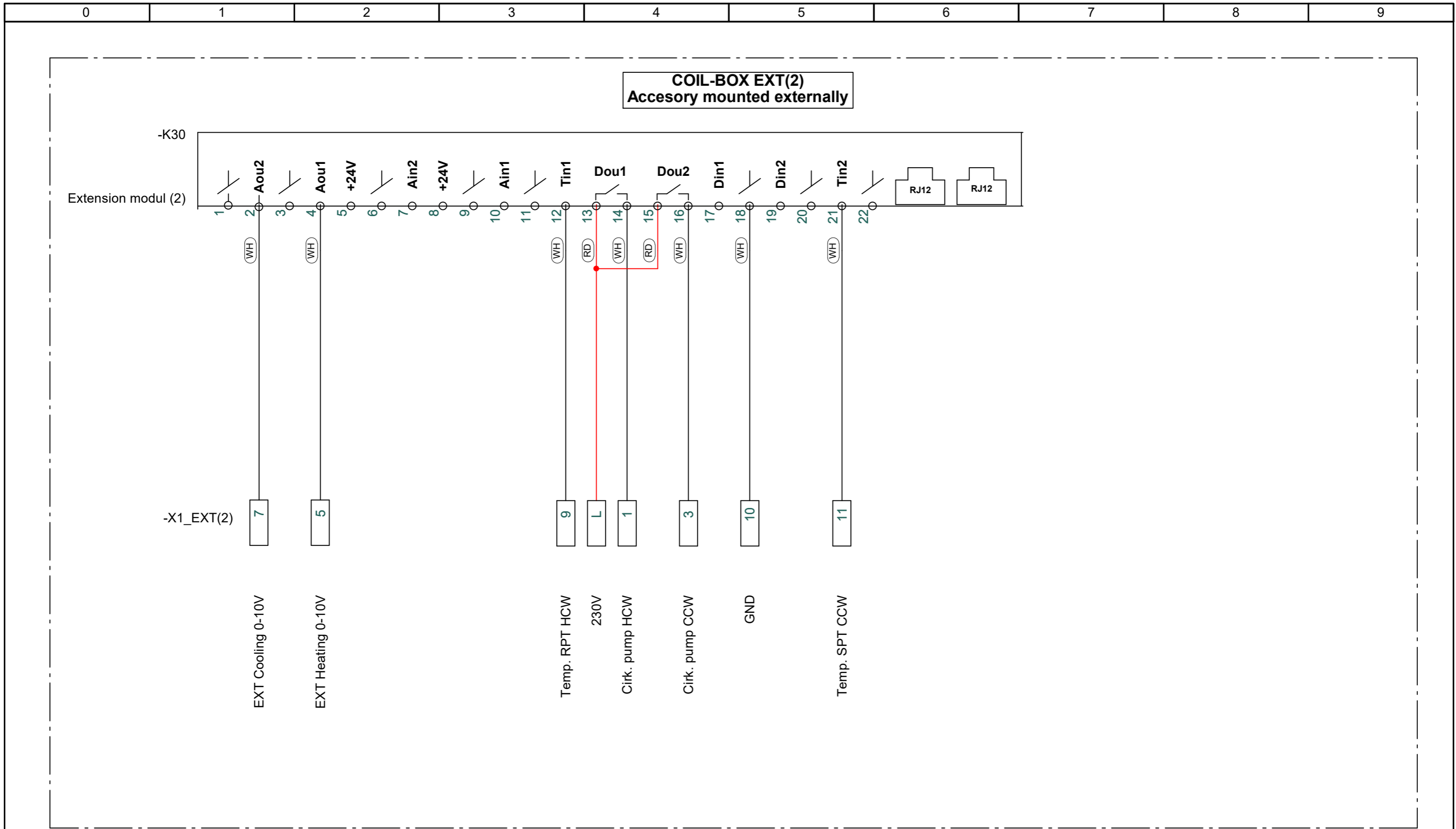

EXHAUSTO

Project:
CX3030 & CX3040

Start date:	24-08-2022	Constructor:	DKTSA	Page:	16
Revision date:	08-11-2023	Approved by:	DKLEG	Previous page:	15
Replaces:	Rev. C	Scale:	1:1	Next page:	17
EC no.:		Format:		Pages in total:	43

Drawing number:
0400102

Revision:
D

Page Title:
Terminal wiring EXT module (2)

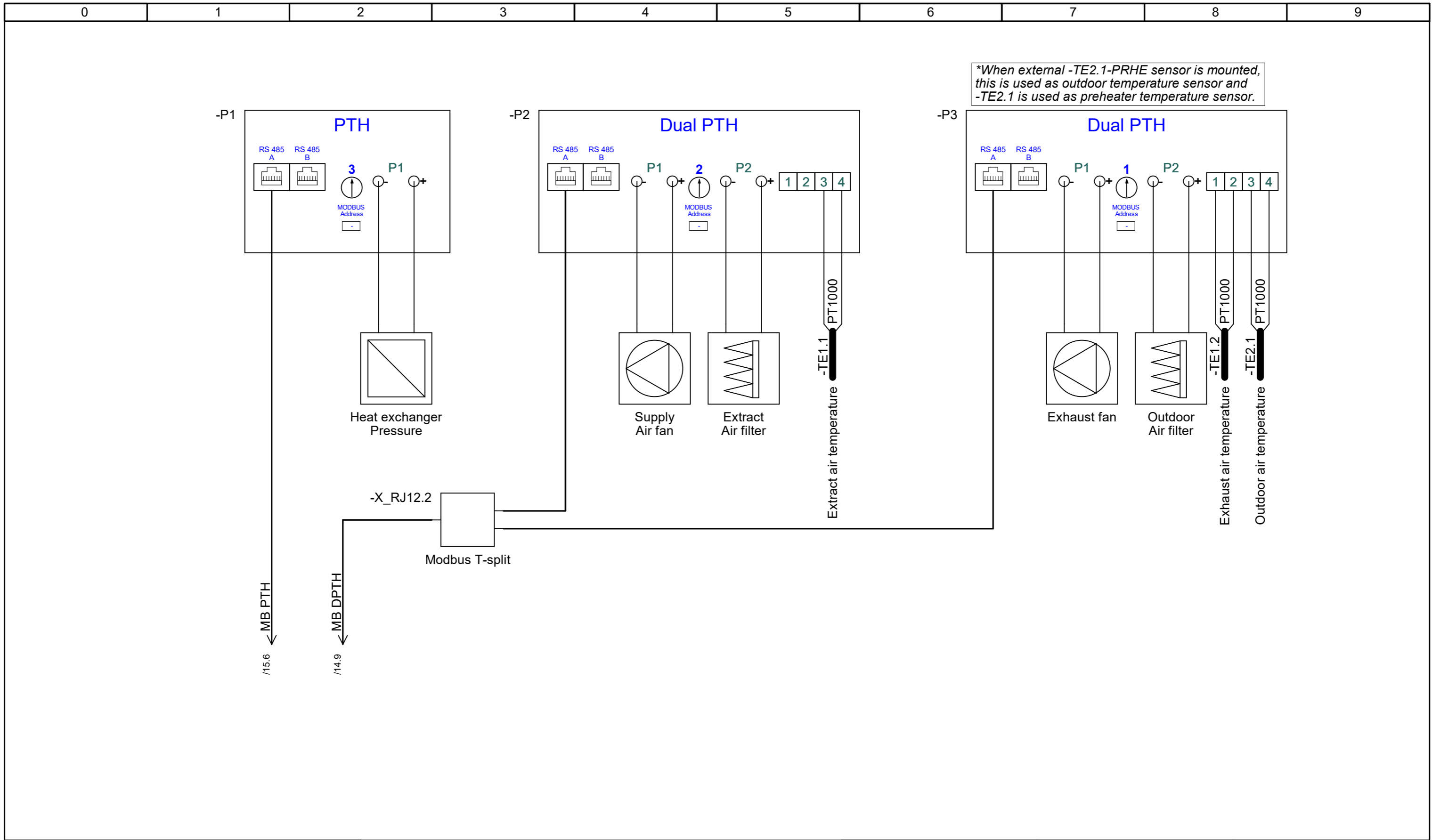

EXHAUSTO	Project: CX3030 & CX3040		Start date: 24-08-2022	Constructor: DKTSA	Page: 17
	Drawing number: 0400102		Revision date: 08-11-2023	Approved by: DKLEG	Previous page: 16
Revision: D	Page Title: PTH connections		Replaces: Rev. C	Scale: 1:1	Next page: 20
			EC no.:	Format:	Pages in total: 43

Configurations

EXHAUSTO	Project: CX3030 & CX3040	Start date: 24-08-2022	Constructor: DKTSA	Page: 20	
		Revision date: 08-11-2023	Approved by: DKLEG	Previous page: 17	
Drawing number: 0400102	Revision: D	Page Title: Configurations	Replaces: Rev. C	Scale: 1:1	Next page: 21
			EC no.:	Format:	Pages in total: 43

Configuration 1: No Coils

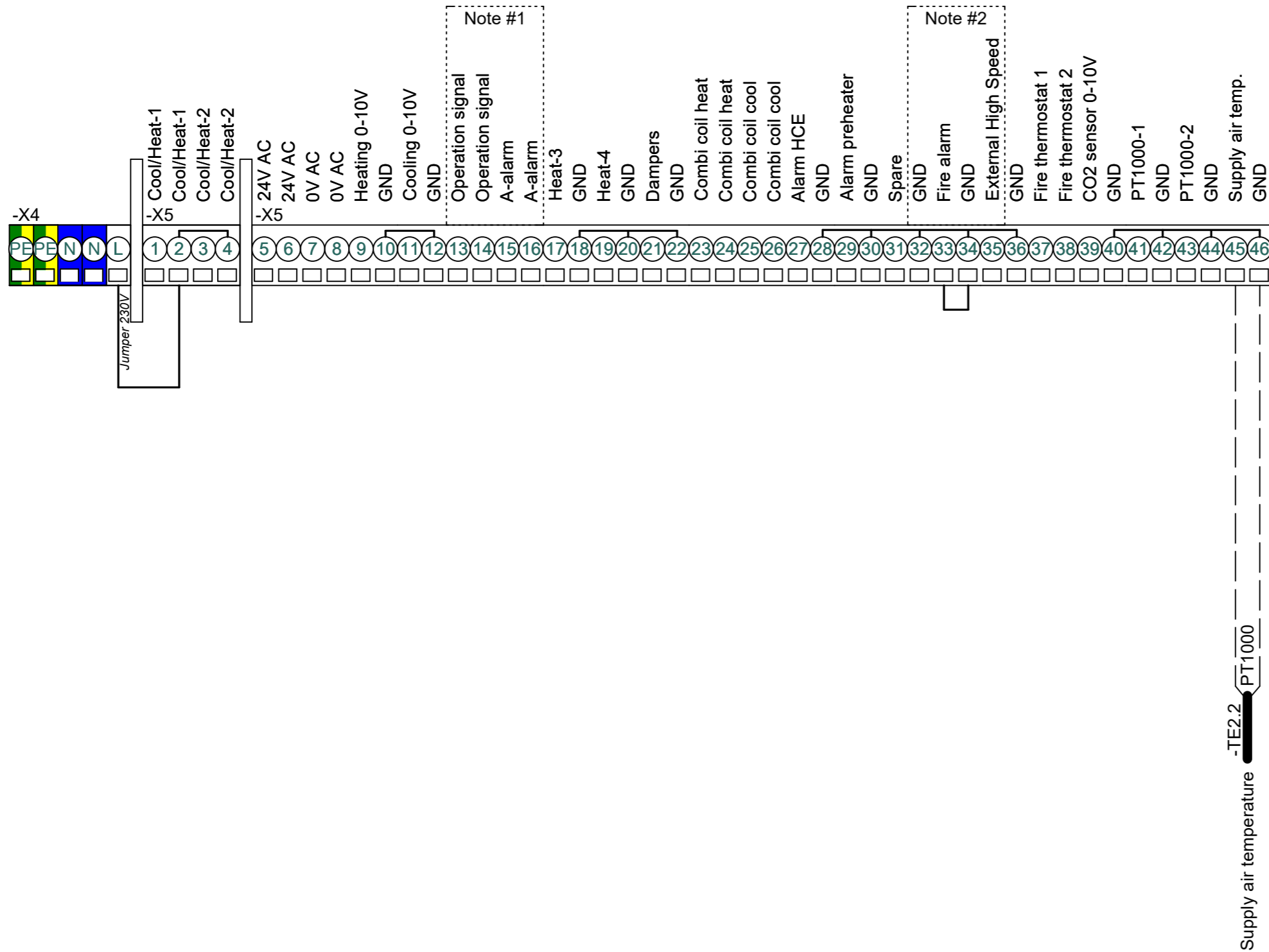

Note #1
 Default configuration.
 Can be changed to:
 - B-alarm output
 - Alarm reset
 - Summer operation
 - Summer night cooling

Note #2
 Default configuration.
 Can be changed to:
 - AHU STOP
 - Low speed
 - Medium speed
 - Frost alarm
 - External start
 - External reset alarms
 If used remove jumper

* Supply air temperature sensor must be mounted in supply air duct after heating and cooling coils

EXHAUSTO	Project:	CX3030 & CX3040	Start date:	24-08-2022	Constructor:	DKTSA	Page:	21			
	Drawing number:	0400102	Revision:	D	Page Title:	Configuration 1: No coils	Revision date:	08-11-2023	Approved by:	DKLEG	Previous page:
					Replaces:	Rev. C	Scale:	1:1	Next page:	22	
					EC no.:		Format:		Pages in total:	43	

Configuration 2: Water Heating Coil

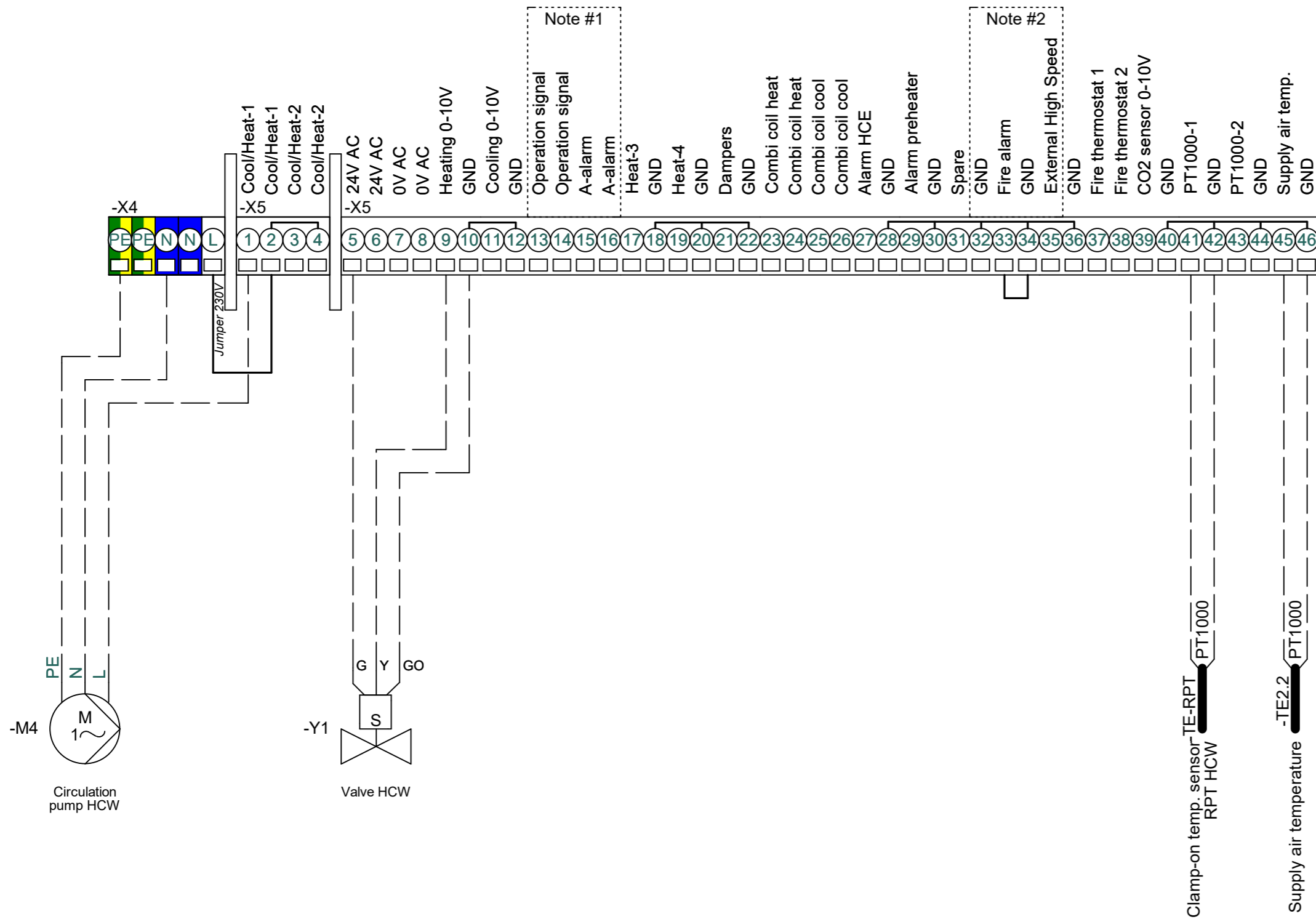

Note #1
 Default configuration.
 Can be changed to:
 - B-alarm output
 - Alarm reset
 - Summer operation
 - Summer night cooling

Note #2
 Default configuration.
 Can be changed to:
 - AHU STOP
 - Low speed
 - Medium speed
 - Frost alarm
 - External start
 - External reset alarms
 If used remove jumper

* Supply air temperature sensor must be mounted in supply air duct after heating and cooling coils

EXHAUSTO	Project:	CX3030 & CX3040	Start date:	24-08-2022	Constructor:	DKTSA	Page:	22	
	Drawing number:	0400102	Revision date:	08-11-2023	Approved by:	DKLEG	Previous page:	21	
Revision:	D	Page Title:	Configuration 2: HCW	Replaces:	Rev. C	Scale:	1:1	Next page:	23
				EC no.:		Format:		Pages in total:	43

Configuration 3: Electric Heating Coil

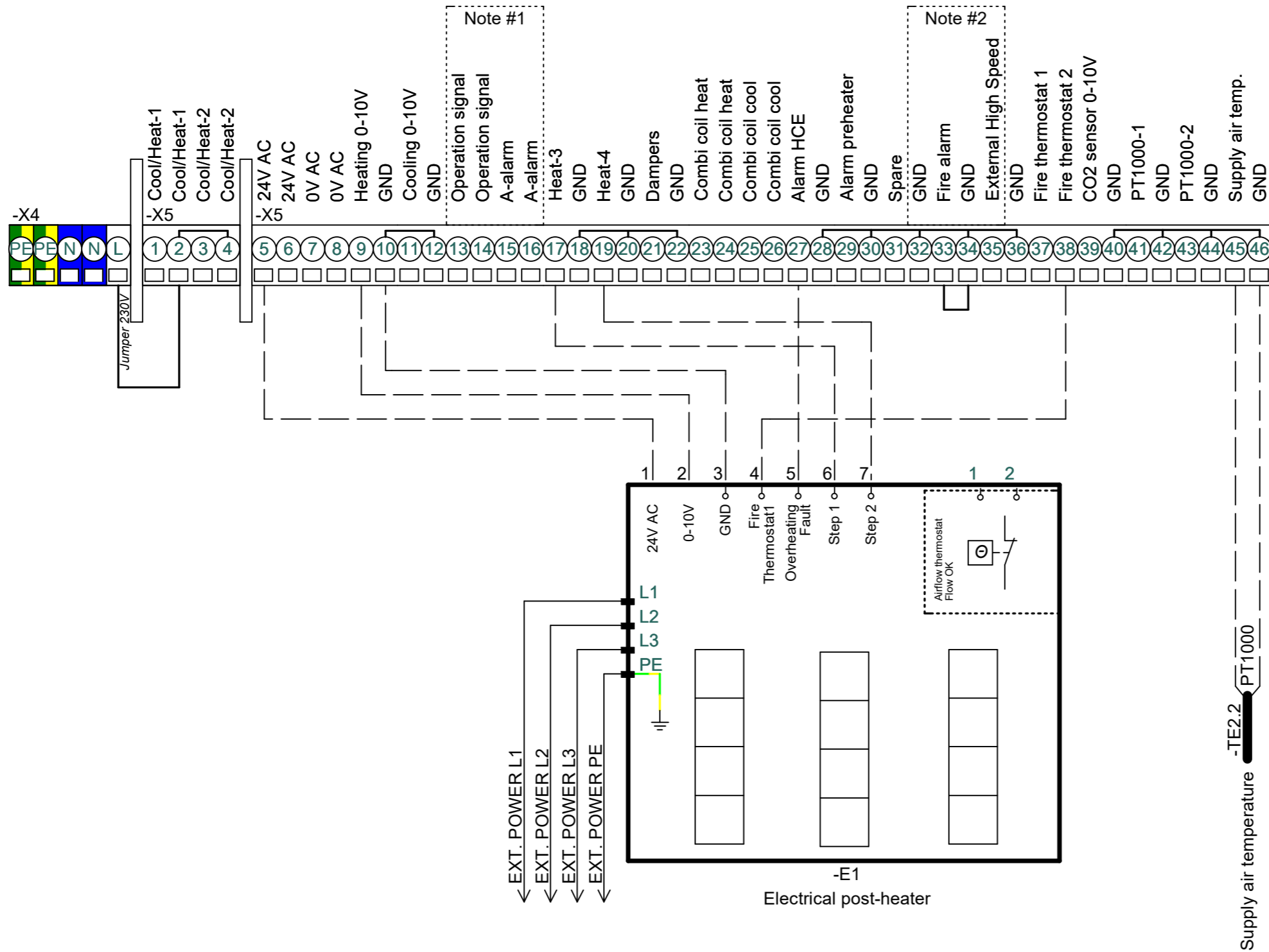

Note #1
 Default configuration.
 Can be changed to:
 - B-alarm output
 - Alarm reset
 - Summer operation
 - Summer night cooling

Note #2
 Default configuration.
 Can be changed to:
 - AHU STOP
 - Low speed
 - Medium speed
 - Frost alarm
 - External start
 - External reset alarms
 If used remove jumper

* Heater Step 2 are only used in the high performance heaters

* Supply air temperature sensor must be mounted in supply air duct after heating and cooling coils

EXHAUSTO	Project:	CX3030 & CX3040	Start date:	24-08-2022	Constructor:	DKTSA	Page:	23			
	Drawing number:	0400102	Revision:	D	Page Title:	Configuration 3: HCE	Revision date:	08-11-2023	Approved by:	DKLEG	Previous page:
			Replaces:	Rev. C	Scale:	1:1	Next page:	24			
			EC no.:		Format:		Pages in total:	43			

Configuration 4: Water Cooling Coil

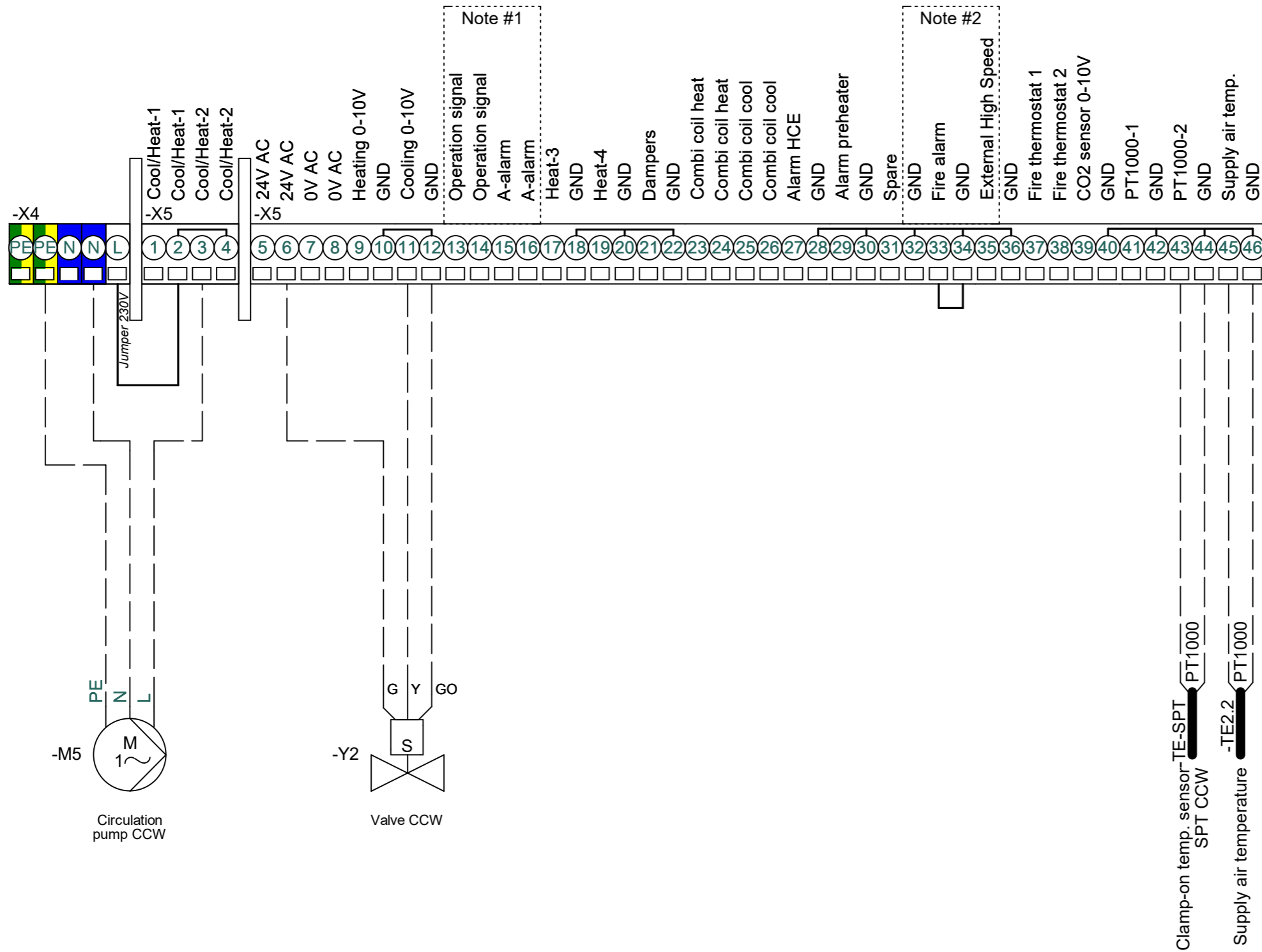

Note #1
 Default configuration.
 Can be changed to:
 - B-alarm output
 - Alarm reset
 - Summer operation
 - Summer night cooling

Note #2
 Default configuration.
 Can be changed to:
 - AHU STOP
 - Low speed
 - Medium speed
 - Frost alarm
 - External start
 - External reset alarms
 If used remove jumper

* Supply air temperature sensor must be mounted in supply air duct after heating and cooling coils

EXHAUSTO	Project:	CX3030 & CX3040	Start date:	24-08-2022	Constructor:	DKTSA	Page:	24			
	Drawing number:	0400102	Revision:	D	Page Title:	Configuration 4: CCW	Revision date:	08-11-2023	Approved by:	DKLEG	Previous page:
			Replaces:	Rev. C	Scale:	1:1	Next page:	25			
			EC no.:		Format:		Pages in total:	43			

Configuration 5: Electric Pre-heater

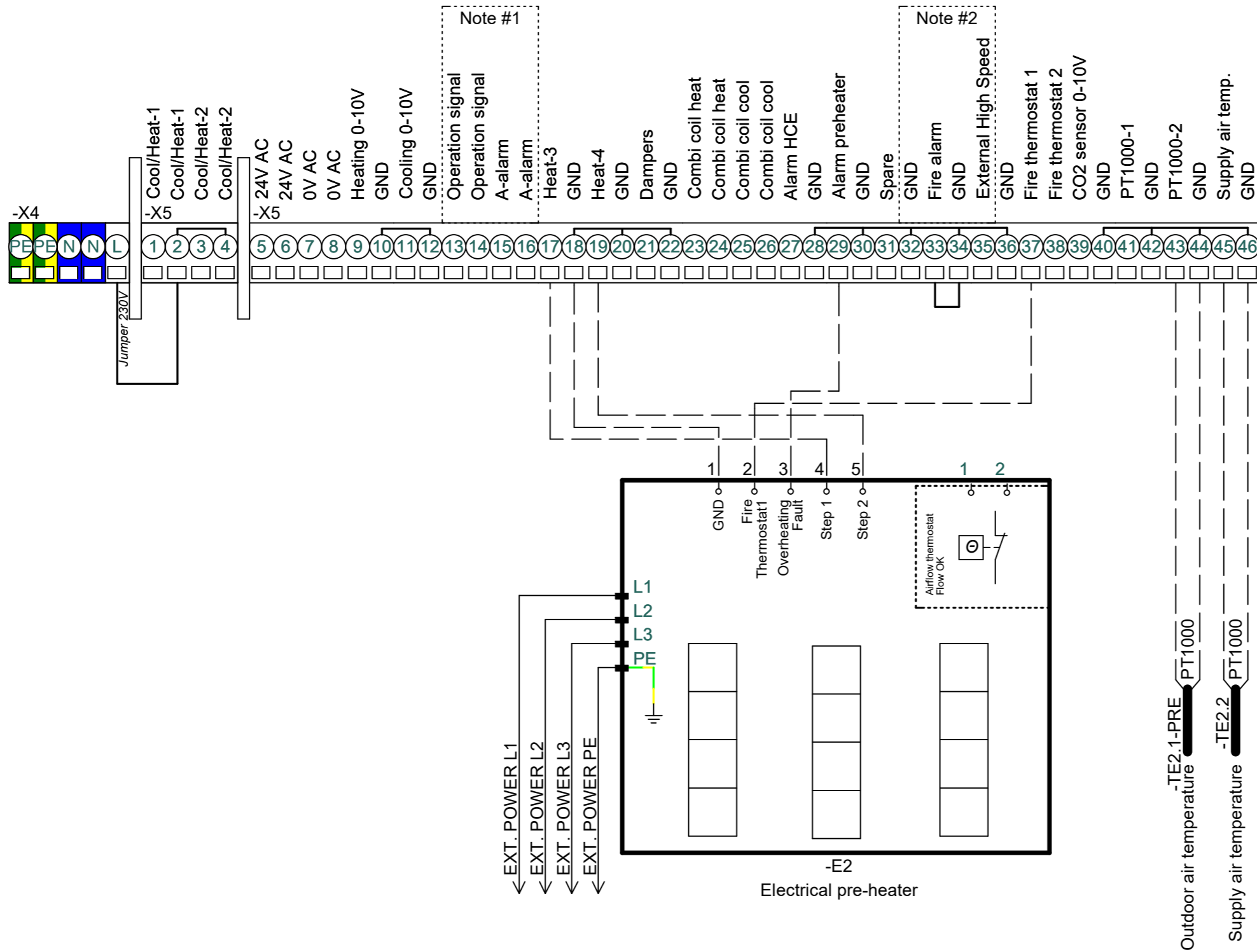

Note #1
 Default configuration.
 Can be changed to:
 - B-alarm output
 - Alarm reset
 - Summer operation
 - Summer night cooling

Note #2
 Default configuration.
 Can be changed to:
 - AHU STOP
 - Low speed
 - Medium speed
 - Frost alarm
 - External start
 - External reset alarms
 If used remove jumper

* Heater Step 2 are only used in the high performance heaters

* Outdoor air temperature sensor must be mounted in the outside air duct, before the preheating coil.

* Supply air temperature sensor must be mounted in supply air duct after heating and cooling coils

EXHAUSTO	Project:	CX3030 & CX3040	Start date:	24-08-2022	Constructor:	DKTSA	Page:	25			
	Drawing number:	0400102	Revision:	D	Page Title:	Configuration 5: Preheater	Revision date:	08-11-2023	Approved by:	DKLEG	Previous page:
					Replaces:	Rev. C	Scale:	1:1	Next page:	26	
					EC no.:		Format:		Pages in total:	43	

Configuration 6: Water Heating Coil + Water cooling coil

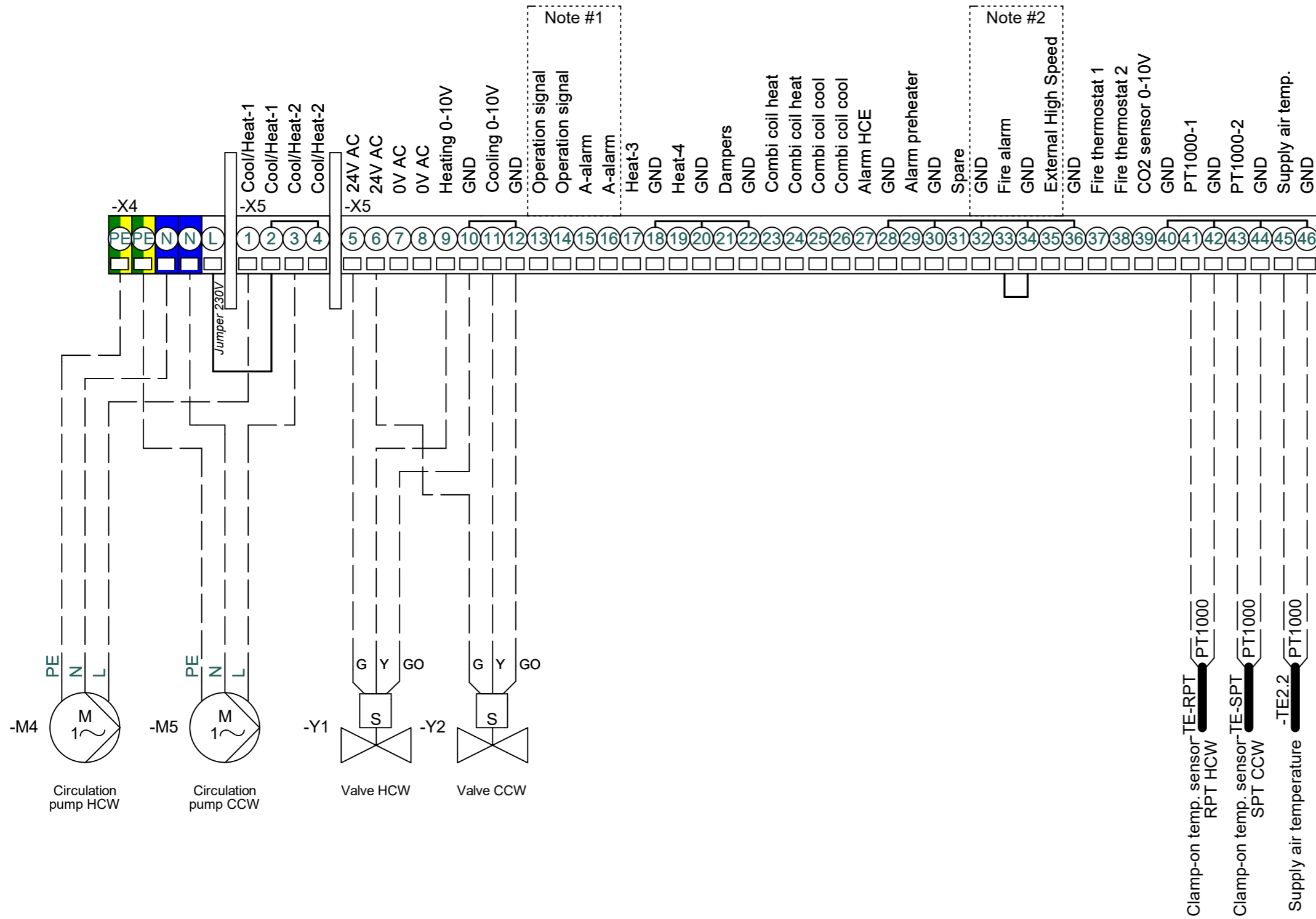

Note #1
 Default configuration.
 Can be changed to:
 - B-alarm output
 - Alarm reset
 - Summer operation
 - Summer night cooling

Note #2
 Default configuration.
 Can be changed to:
 - AHU STOP
 - Low speed
 - Medium speed
 - Frost alarm
 - External start
 - External reset alarms
 If used remove jumper

* Supply air temperature sensor must be mounted in supply air duct after heating and cooling coils

EXHAUSTO

Project:
CX3030 & CX3040

Start date:	24-08-2022	Constructor:	DKTSA	Page:	26
Revision date:	08-11-2023	Approved by:	DKLEG	Previous page:	25
Replaces:	Rev. C	Scale:	1:1	Next page:	27
EC no.:		Format:		Pages in total:	43

Drawing number:
0400102

Revision:
D

Page Title:
Configuration 6: HCW+CCW

Connections configuration 7: Electric Heating Coil + Water Cooling Coil

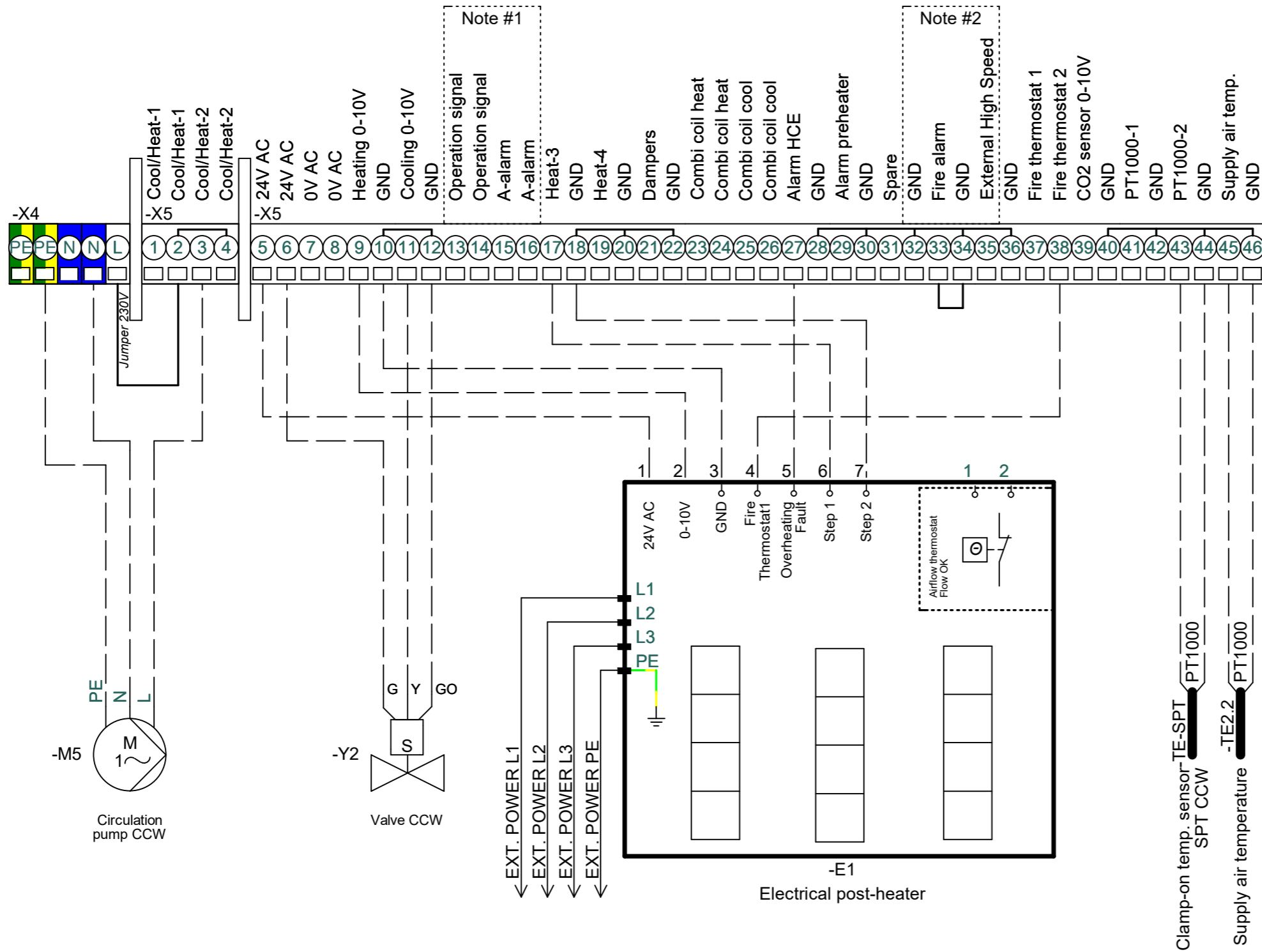

Note #1
 Default configuration.
 Can be changed to:
 - B-alarm output
 - Alarm reset
 - Summer operation
 - Summer night cooling

Note #2
 Default configuration.
 Can be changed to:
 - AHU STOP
 - Low speed
 - Medium speed
 - Frost alarm
 - External start
 - External reset alarms
 If used remove jumper

* Heater Step 2 are only used in the high performance heaters

* Supply air temperature sensor must be mounted in supply air duct after heating and cooling coils

EXHAUSTO

Project: CX3030 & CX3040

Start date:	24-08-2022	Constructor:	DKTSA	Page:	27
Revision date:	08-11-2023	Approved by:	DKLEG	Previous page:	26
Replaces:	Rev. C	Scale:	1:1	Next page:	28
EC no.:		Format:		Pages in total:	43

Drawing number: 0400102

Revision: D

Page Title: Configuration 7: HCE+CCW

Connections configuration 8: Electric Preheating Coil + Water Heating Coil

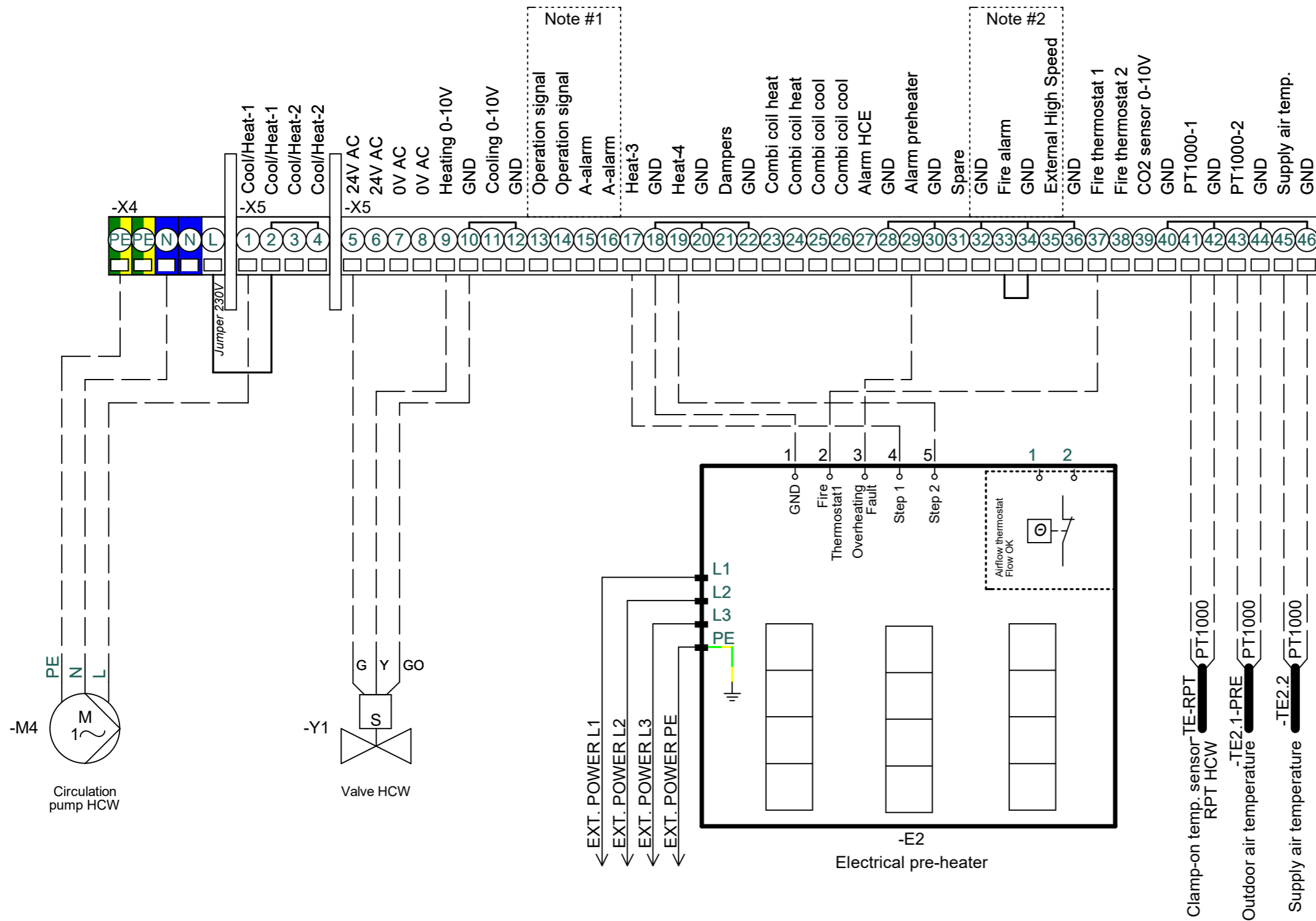

Note #1
 Default configuration.
 Can be changed to:
 - B-alarm output
 - Alarm reset
 - Summer operation
 - Summer night cooling

Note #2
 Default configuration.
 Can be changed to:
 - AHU STOP
 - Low speed
 - Medium speed
 - Frost alarm
 - External start
 - External reset alarms
 If used remove jumper

* Heater Step 2 are only used in the high performance heaters

* Outdoor air temperature sensor must be mounted in the outside air duct, before the preheating coil.

* Supply air temperature sensor must be mounted in supply air duct after heating and cooling coils

EXHAUSTO	Project:	CX3030 & CX3040	Start date:	24-08-2022	Constructor:	DKTSA	Page:	28	
	Drawing number:	0400102	Revision:	D	Revision date:	08-11-2023	Approved by:	DKLEG	Previous page:
Page Title:		Configuration 8: Preheater+HCW	Replaces:	Rev. C	Scale:	1:1	Next page:	29	
EC no.:			Format:		Pages in total:	43			

Connections configuration 9: Electric Preheating Coil + Water Cooling Coil

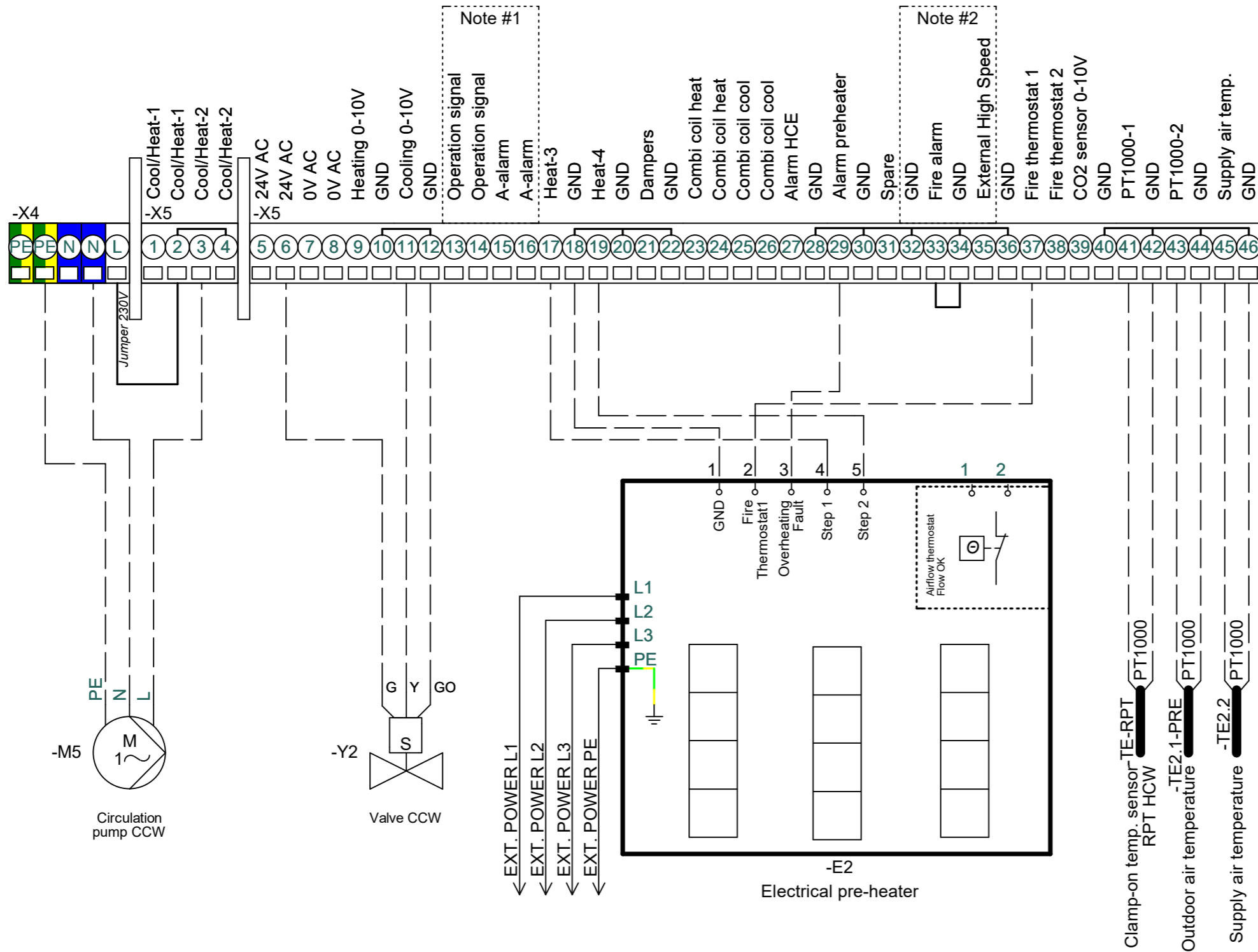

Note #1
 Default configuration.
 Can be changed to:
 - B-alarm output
 - Alarm reset
 - Summer operation
 - Summer night cooling

Note #2
 Default configuration.
 Can be changed to:
 - AHU STOP
 - Low speed
 - Medium speed
 - Frost alarm
 - External start
 - External reset alarms
 If used remove jumper

* Heater Step 2 are only used in the high performance heaters

* Outdoor air temperature sensor must be mounted in the outside air duct, before the preheating coil.

* Supply air temperature sensor must be mounted in supply air duct after heating and cooling coils

EXHAUSTO	Project:	CX3030 & CX3040	Start date:	24-08-2022	Constructor:	DKTSA	Page:	29			
	Drawing number:	0400102	Revision:	D	Page Title:	Configuration 9: Preheater+CCW	Revision date:	08-11-2023	Approved by:	DKLEG	Previous page:
					Replaces:	Rev. C	Scale:	1:1	Next page:	30	
					EC no.:		Format:		Pages in total:	43	

Connections configuration 10: Electric Preheating Coil + Electric Postheating Coil

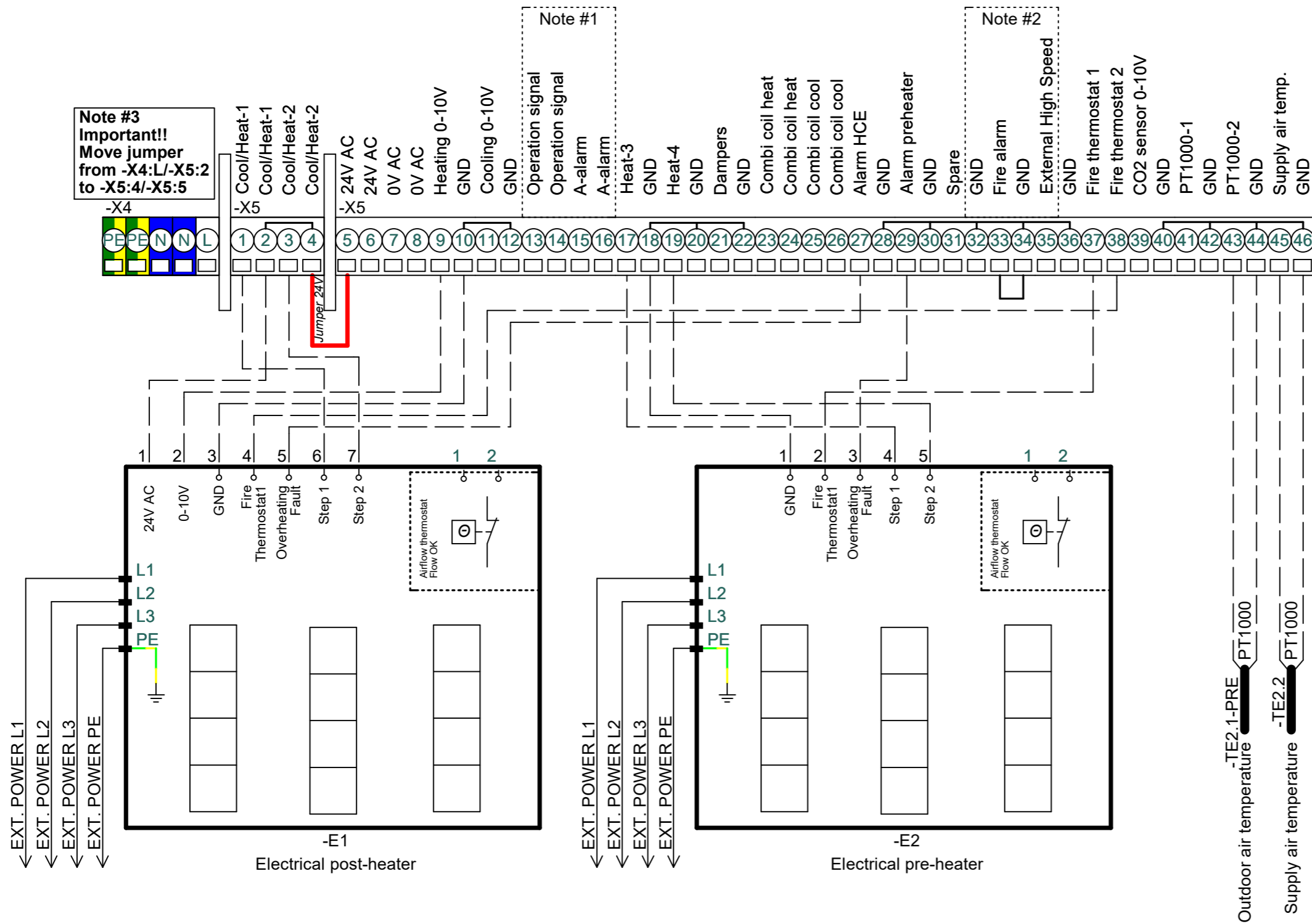

* Heater Step 2 are only used in the high performance heaters

* Outdoor air temperature sensor must be mounted in the outside air duct, before the preheating coil.

* Supply air temperature sensor must be mounted in supply air duct after heating and cooling coils

EXHAUSTO	Project:	CX3030 & CX3040	Start date:	24-08-2022	Constructor:	DKTSA	Page:	30			
	Drawing number:	0400102	Revision:	D	Page Title:	Configuration 10: Preheater+HCE	Revision date:	08-11-2023	Approved by:	DKLEG	Previous page:
					Replaces:	Rev. C	Scale:	1:1	Next page:	31	
					EC no.:		Format:		Pages in total:	43	

Configuration 11: Preheater + Water Heating Coil + Water Cooling Coil

Continued on page 32

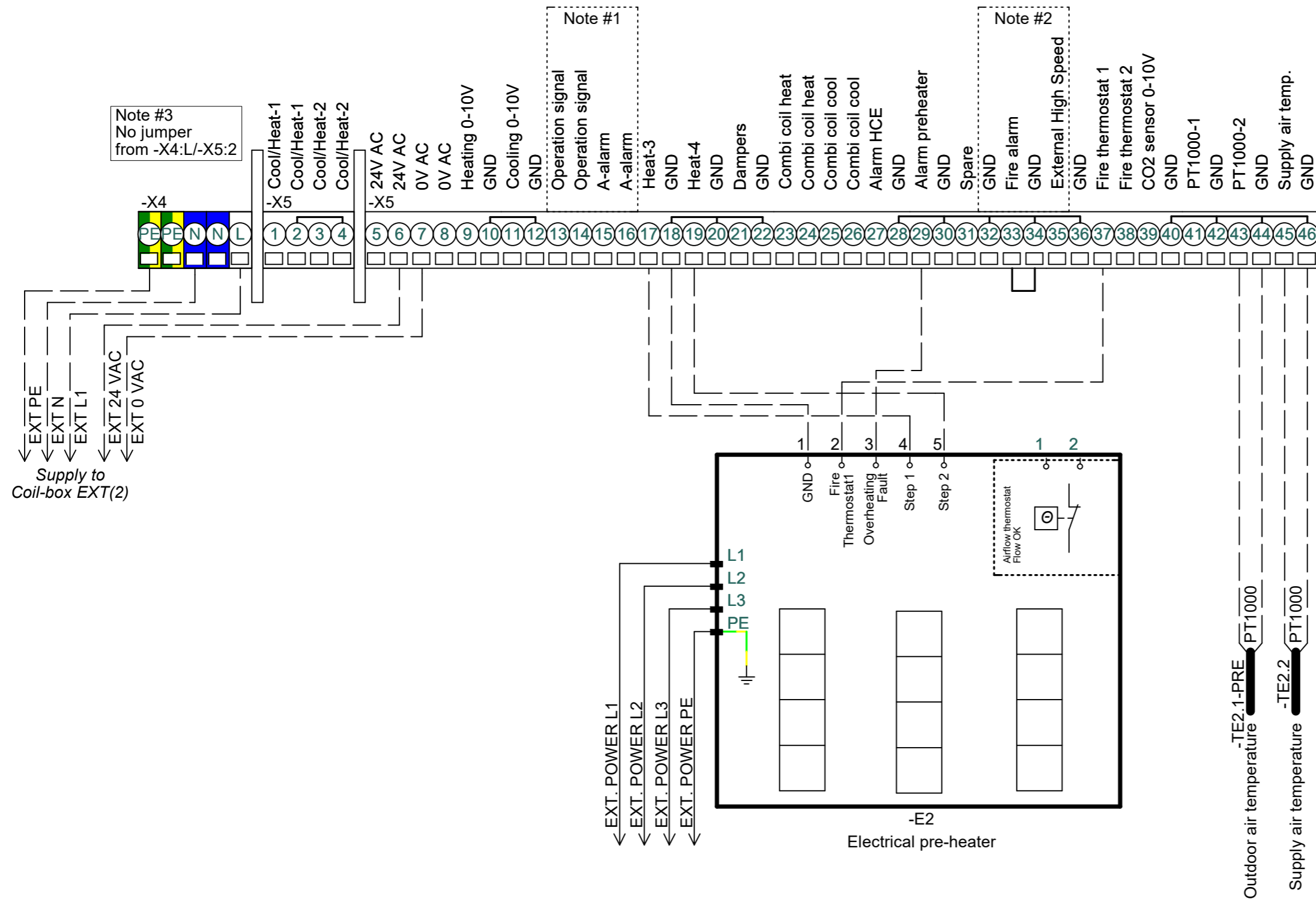

Note #1
 Default configuration.
 Can be changed to:
 - B-alarm output
 - Alarm reset
 - Summer operation
 - Summer night cooling

Note #2
 Default configuration.
 Can be changed to:
 - AHU STOP
 - Low speed
 - Medium speed
 - Frost alarm
 - External start
 - External reset alarms
 If used remove jumper

* Heater Step 2 are only used in the high performance heaters

* Outdoor air temperature sensor must be mounted in the outside air duct, before the preheating coil.

* Supply air temperature sensor must be mounted in supply air duct after heating and cooling coils

* For connecting 3 heating/cooling coils an additional EXT Module is needed. This is addressed with Modbus ID #2. For connecting HCW and CCW please see next page

EXHAUSTO	Project:	CX3030 & CX3040	Start date:	24-08-2022	Constructor:	DKTSA	Page:	31	
	Drawing number:	0400102	Revision:	D	Revision date:	08-11-2023	Approved by:	DKLEG	Previous page:
Page Title:		Configuration 11: Preheater+HCW+CCW	Replaces:	Rev. C	Scale:	1:1	Next page:	32	
EC no.:			Format:		Pages in total:	43			

Configuration 11: Preheater + Water Heating Coil + Water Cooling Coil

Continued from page 31

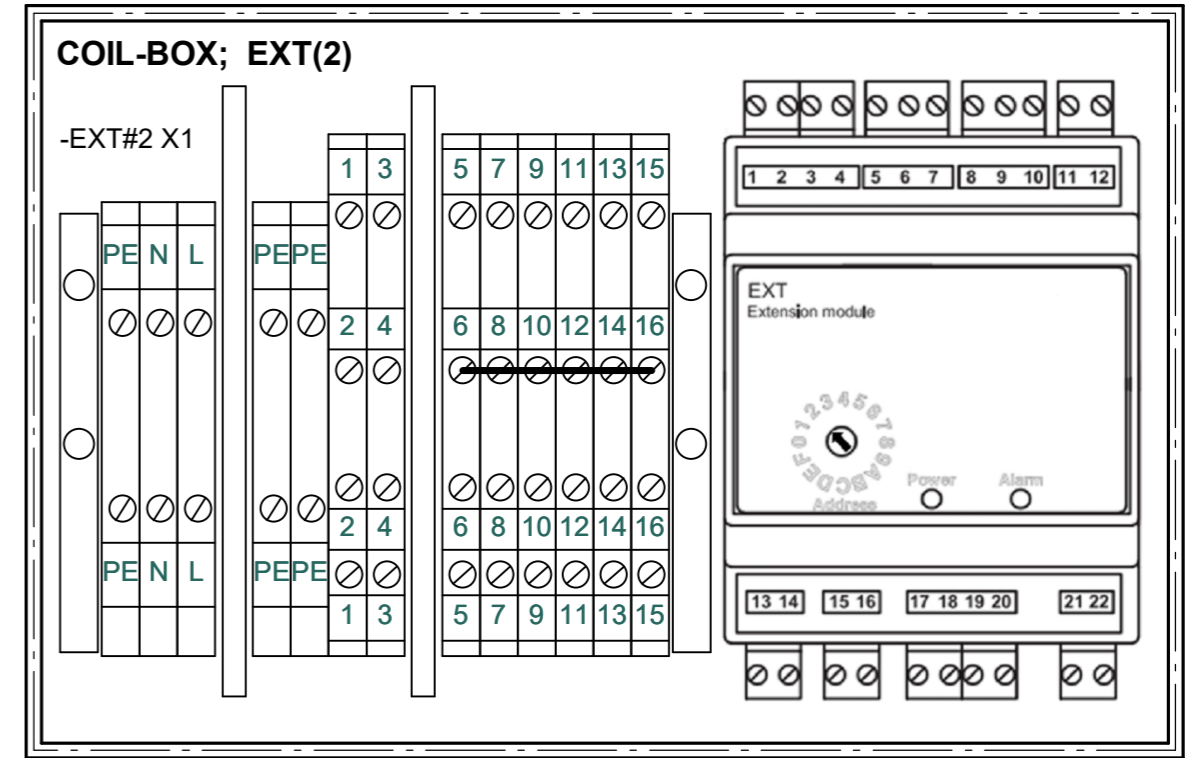
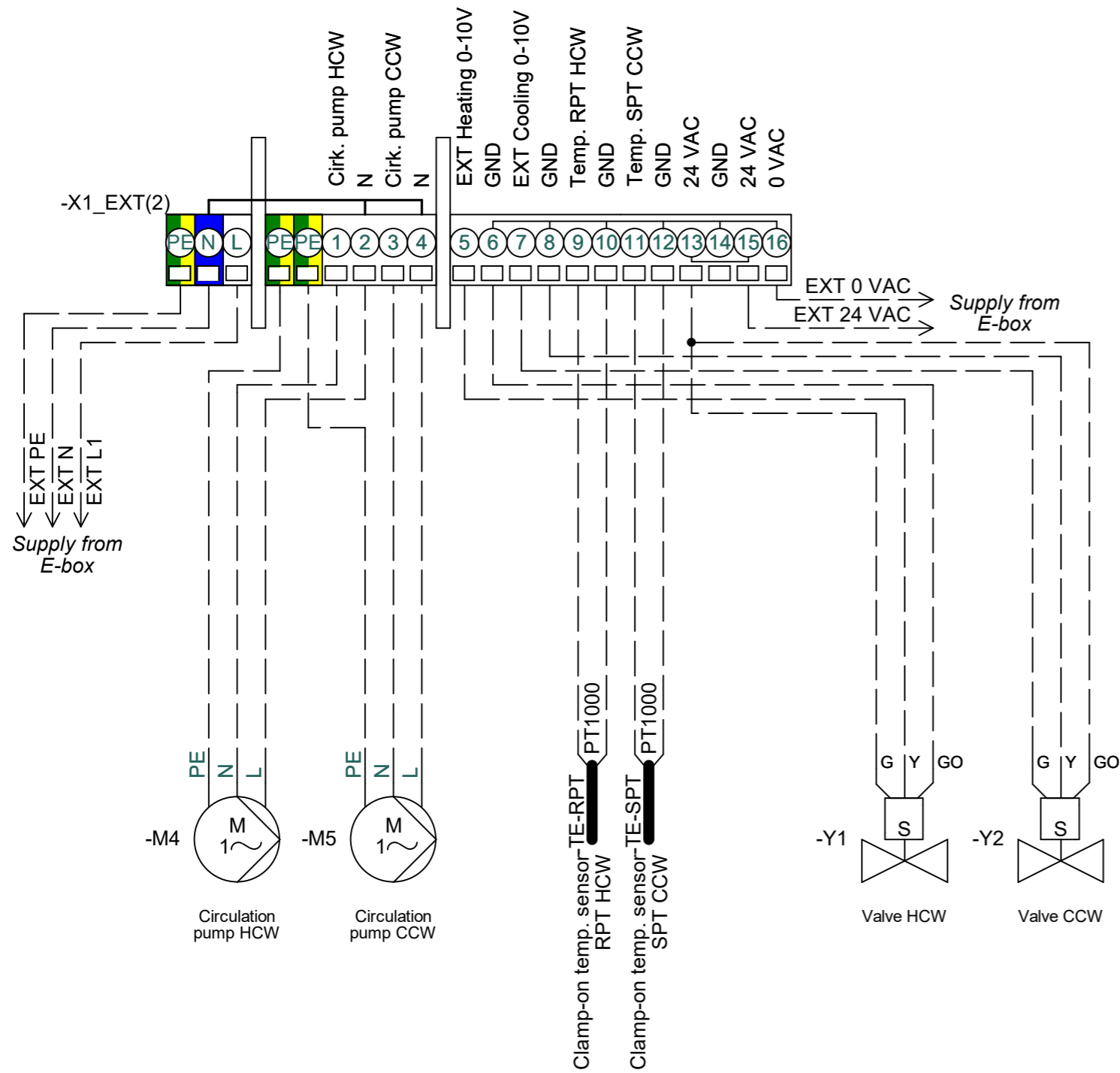

Note #1
Modbus connection to EXcon Master in E-box

EXHAUSTO

Project:
CX3030 & CX3040

Start date:	24-08-2022	Constructor:	DKTSA	Page:	32
Revision date:	08-11-2023	Approved by:	DKLEG	Previous page:	31
Replaces:	Rev. C	Scale:	1:1	Next page:	33
EC no.:		Format:		Pages in total:	43

Drawing number:
0400102

Revision:
D

Page Title:
Configuration 11: Preheater+HCW+CCW

Connections configuration 12: Electric Preheating Coil + Electric Postheating Coil + Water Cooling Coil

Continued on page 34

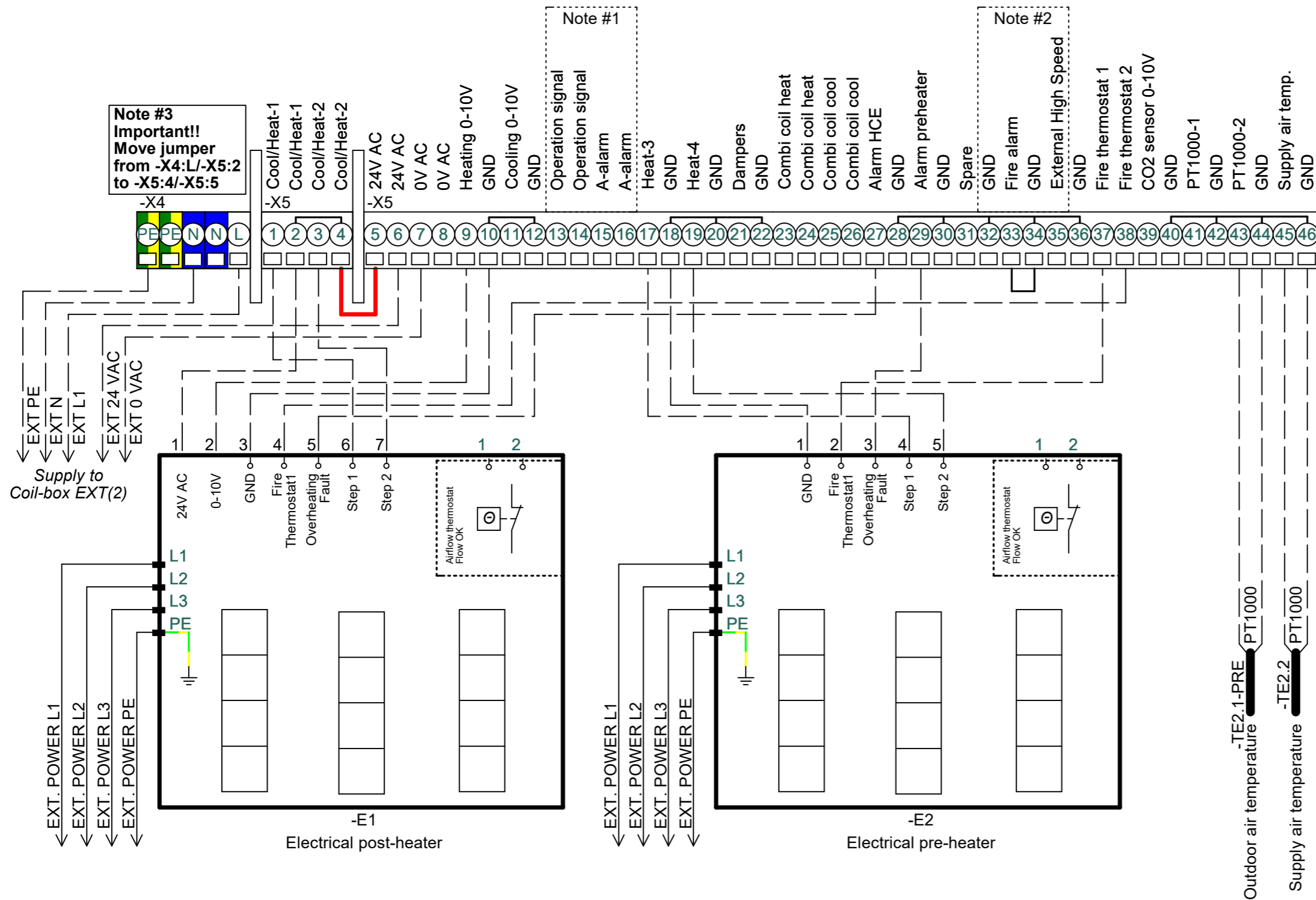

Note #1
 Default configuration.
 Can be changed to:
 - B-alarm output
 - Alarm reset
 - Summer operation
 - Summer night cooling

Note #2
 Default configuration.
 Can be changed to:
 - AHU STOP
 - Low speed
 - Medium speed
 - Frost alarm
 - External start
 - External reset alarms
 If used remove jumper

* Heater Step 2 are only used in the high performance heaters

* Outdoor air temperature sensor must be mounted in the outside air duct, before the preheating coil.

* Supply air temperature sensor must be mounted in supply air duct after heating and cooling coils

* For connecting 3 heating/cooling coils an additional EXT Module is needed. This is addressed with Modbus ID #2. For connecting HCW and CCW please see next page

EXHAUSTO	Project:	CX3030 & CX3040	Start date:	24-08-2022	Constructor:	DKTSA	Page:	33	
	Drawing number:	0400102	Revision:	D	Revision date:	08-11-2023	Approved by:	DKLEG	Previous page:
Page Title:		Configuration 12: Preheater+HCE+CCW	Replaces:	Rev. C	Scale:	1:1	Next page:	34	
			EC no.:		Format:		Pages in total:	43	

Connections configuration 12: Electric Preheating Coil + Electric Heating Coil + Water Cooling Coil

Continued from page 33

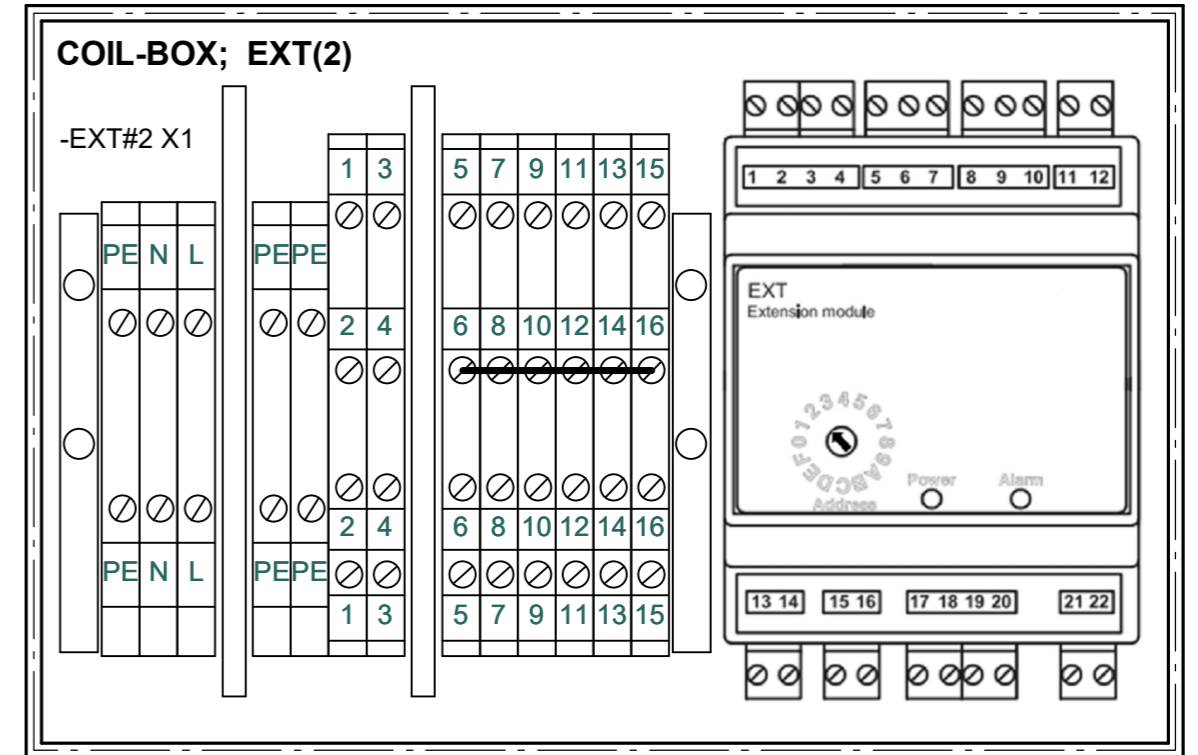
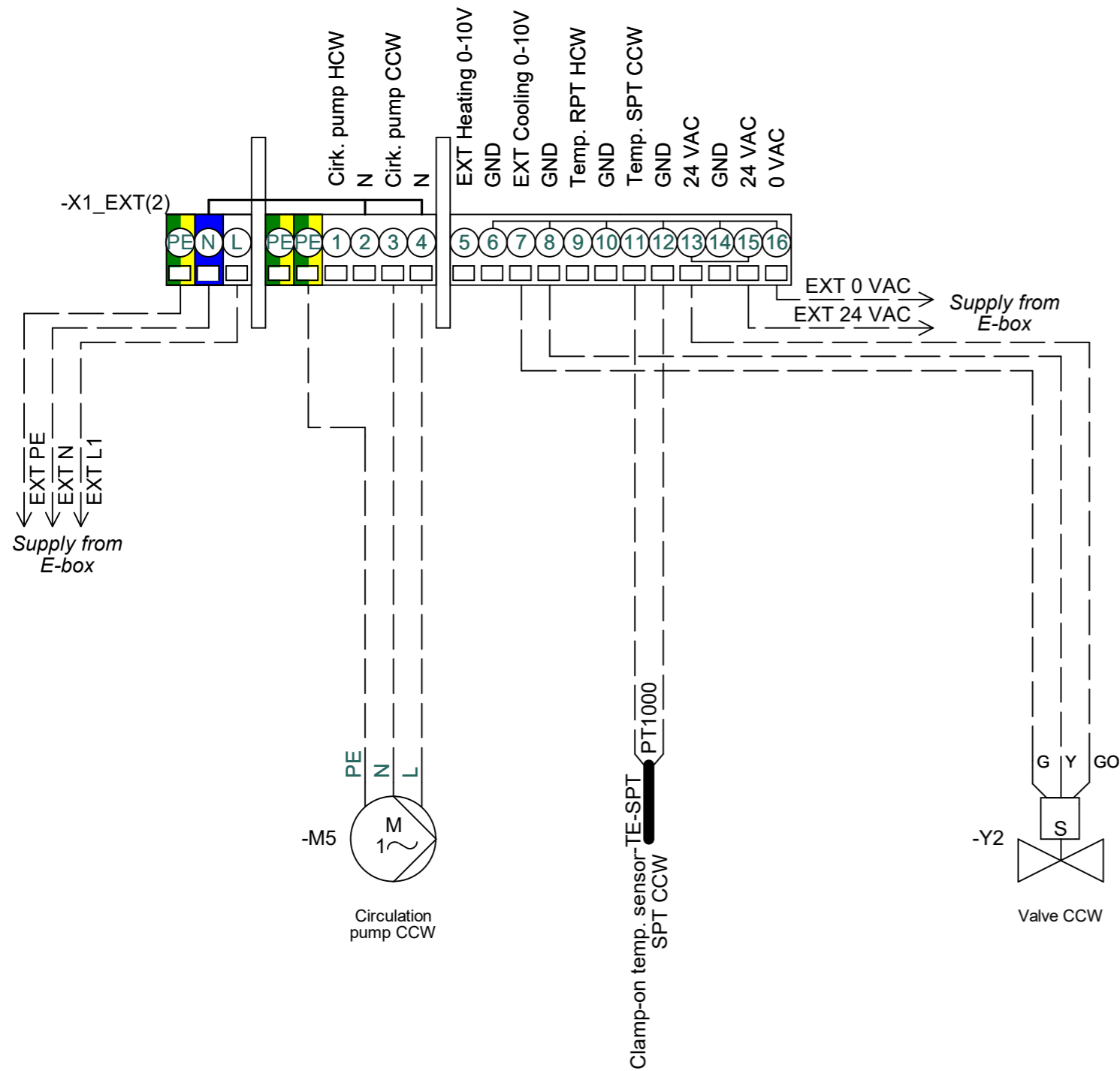

Note #1
Modbus connection to EXcon Master in E-box

EXHAUSTO

Project:
CX3030 & CX3040

Start date:	24-08-2022	Constructor:	DKTSA	Page:	34
Revision date:	08-11-2023	Approved by:	DKLEG	Previous page:	33
Replaces:	Rev. C	Scale:	1:1	Next page:	35
EC no.:		Format:		Pages in total:	43

Drawing number:
0400102

Revision:
D

Page Title:
Configuration 12: Preheater+HCE+CCW

Configuration 13: Change-Over CW (Combi-Coil)

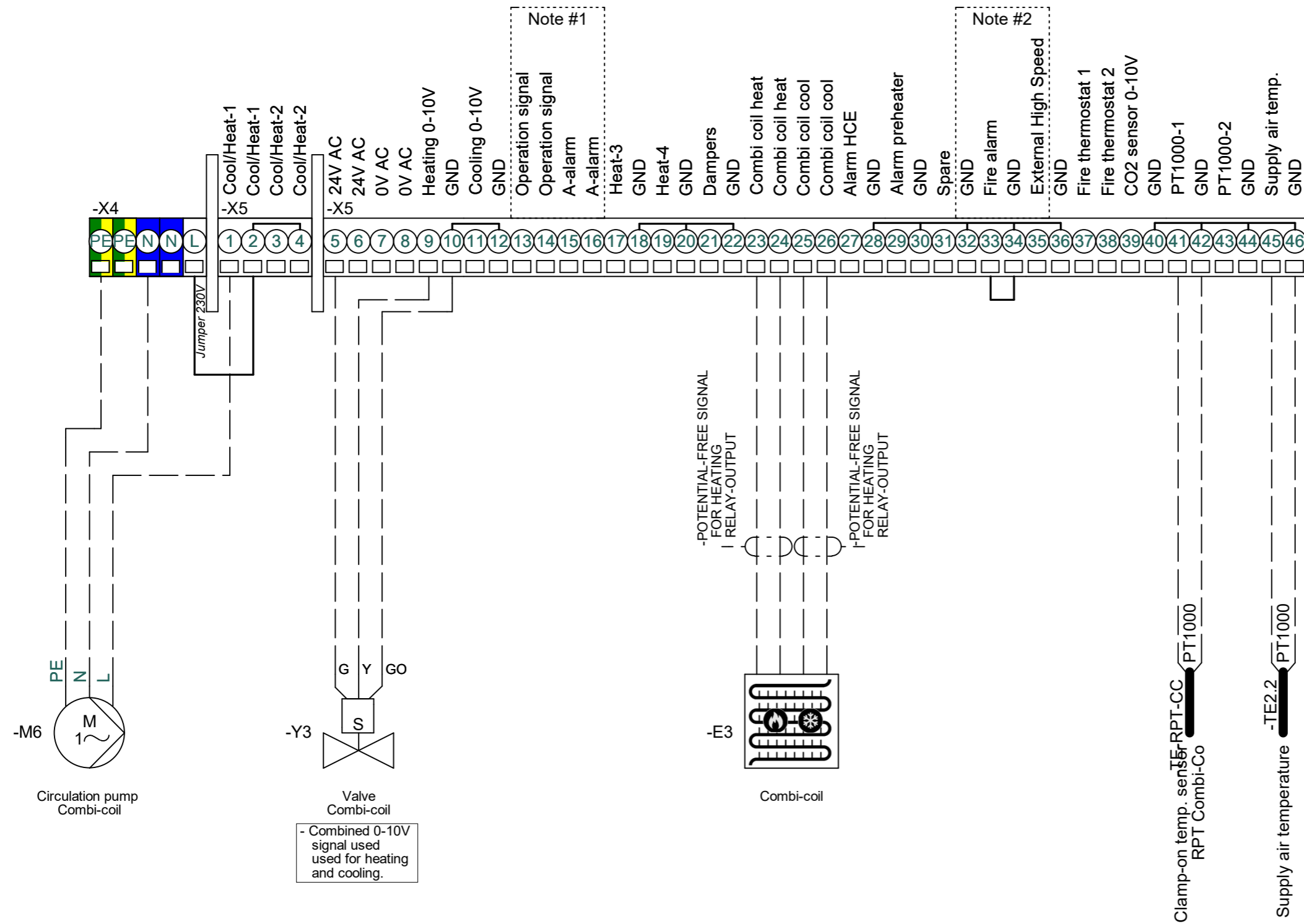

* Supply air temperature sensor must be mounted in supply air duct after heating and cooling coils

EXHAUSTO	Project:	CX3030 & CX3040	Start date:	24-08-2022	Constructor:	DKTSA	Page:	35			
	Drawing number:	0400102	Revision:	D	Page Title:	Configuration 13: C-O CW (Combi-Coil)	Revision date:	08-11-2023	Approved by:	DKLEG	Previous page:
					Replaces:	Rev. C	Scale:	1:1	Next page:	36	
					EC no.:		Format:		Pages in total:	43	

Connections configuration 14: Preheater + C-O CW (Combi-Coil)

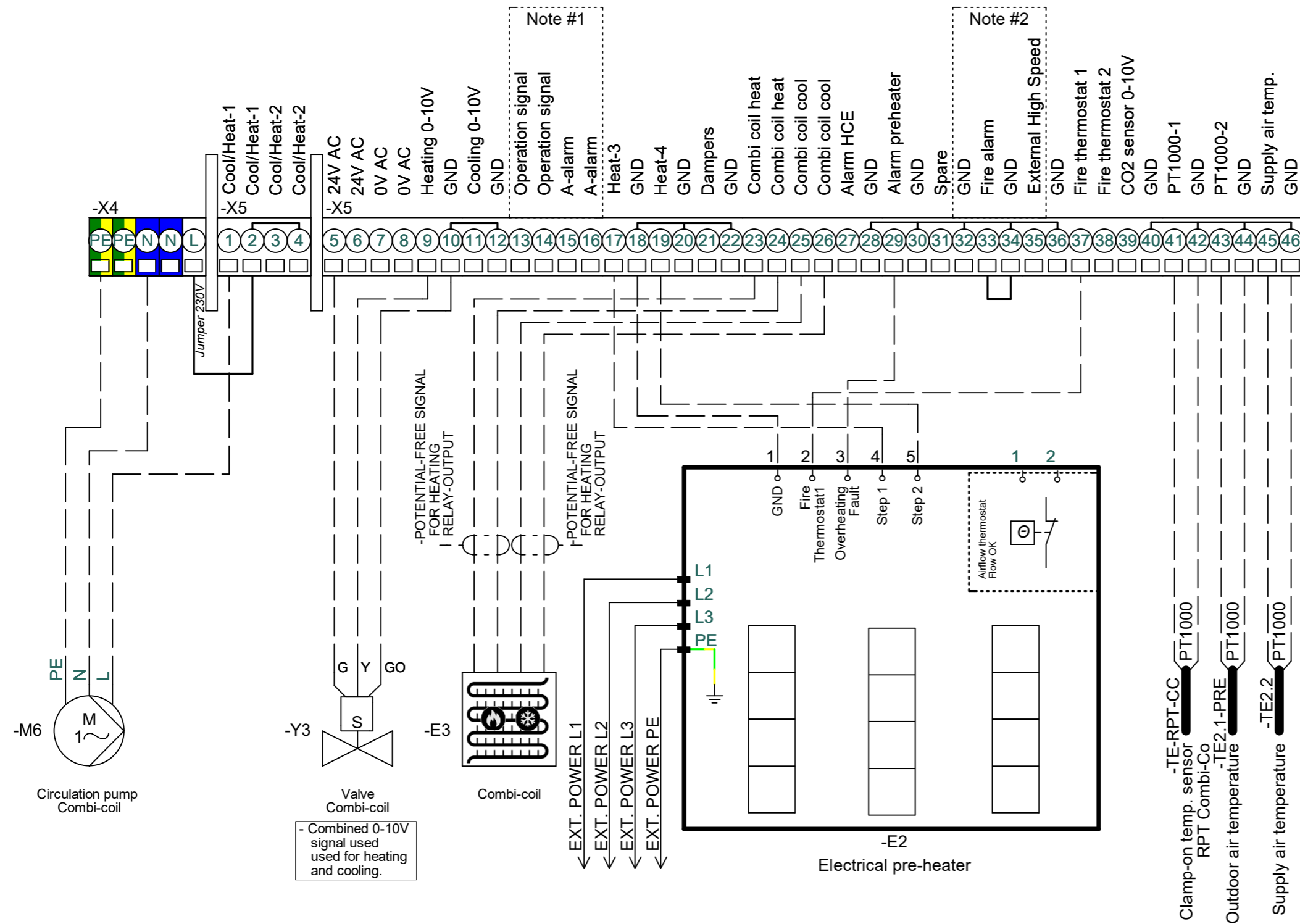

Note #1
 Default configuration.
 Can be changed to:
 - B-alarm output
 - Alarm reset
 - Summer operation
 - Summer night cooling

Note #2
 Default configuration.
 Can be changed to:
 - AHU STOP
 - Low speed
 - Medium speed
 - Frost alarm
 - External start
 - External reset alarms
 If used remove jumper

* Heater Step 2 are only used in the high performance heaters

* Outdoor air temperature sensor must be mounted in the outside air duct, before the preheating coil.

* Supply air temperature sensor must be mounted in supply air duct after heating and cooling coils

EXHAUSTO	Project:	CX3030 & CX3040	Start date:	24-08-2022	Constructor:	DKTSA	Page:	36	
	Drawing number:	0400102	Revision:	D	Revision date:	08-11-2023	Approved by:	DKLEG	Previous page:
Page Title:		Configuration 14: Preheater+Combi-Coil	Replaces:	Rev. C	Scale:	1:1	Next page:	37	
			EC no.:		Format:		Pages in total:	43	

Optional accessories

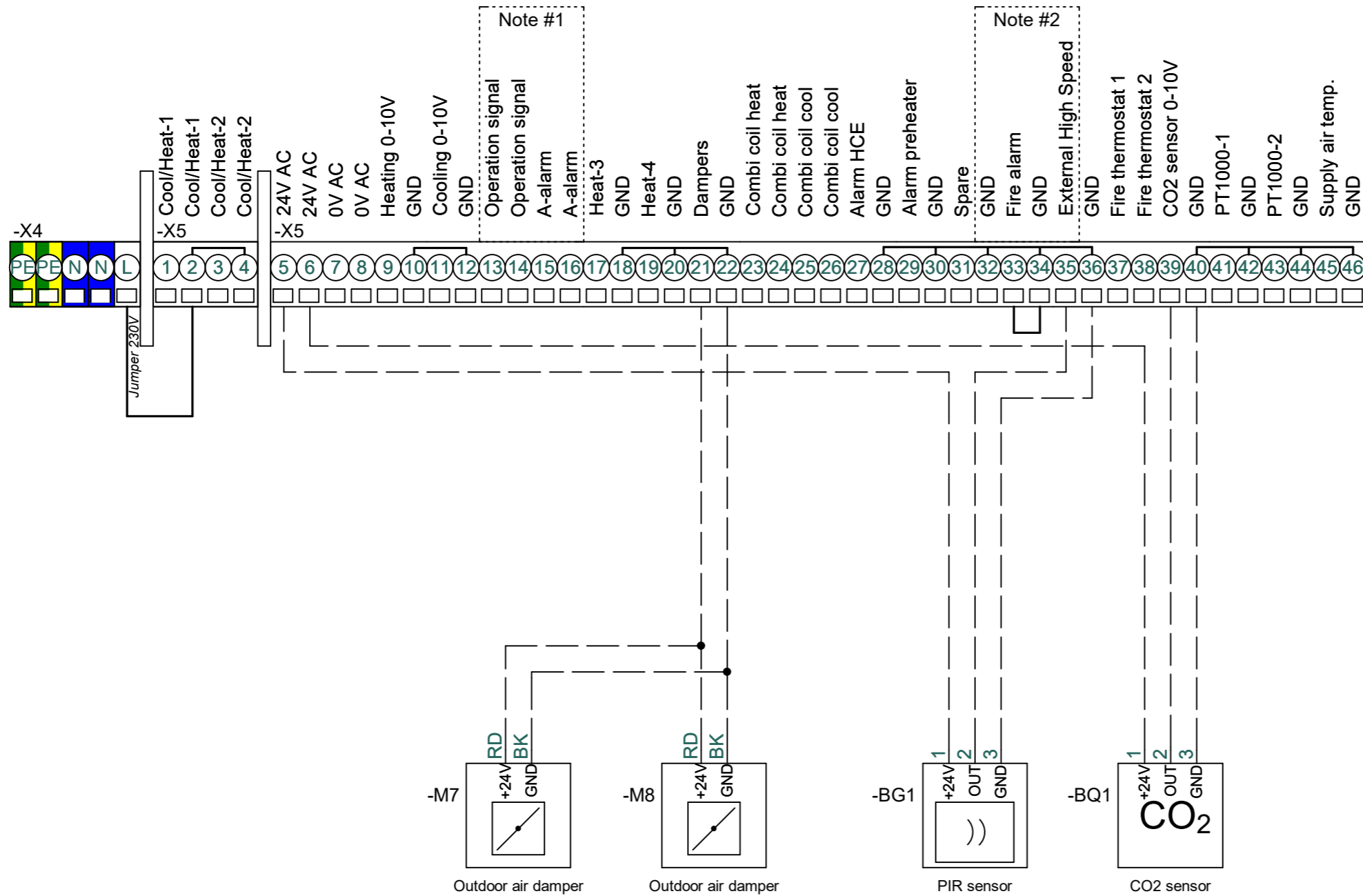

Note #1
 Default configuration.
 Can be changed to:
 - B-alarm output
 - Alarm reset
 - Summer operation
 - Summer night cooling

Note #2
 Default configuration.
 Can be changed to:
 - AHU STOP
 - Low speed
 - Medium speed
 - Frost alarm
 - External start
 - External reset alarms

If used remove jumper

EXHAUSTO	Project:	CX3030 & CX3040	Start date:	24-08-2022	Constructor:	DKTSA	Page:	37	
	Drawing number:	0400102	Revision date:	08-11-2023	Approved by:	DKLEG	Previous page:	36	
Revision:	D	Page Title:	Optional accessories	Replaces:	Rev. C	Scale:	1:1	Next page:	38
				EC no.:		Format:		Pages in total:	43

Optional accessories MODBUS

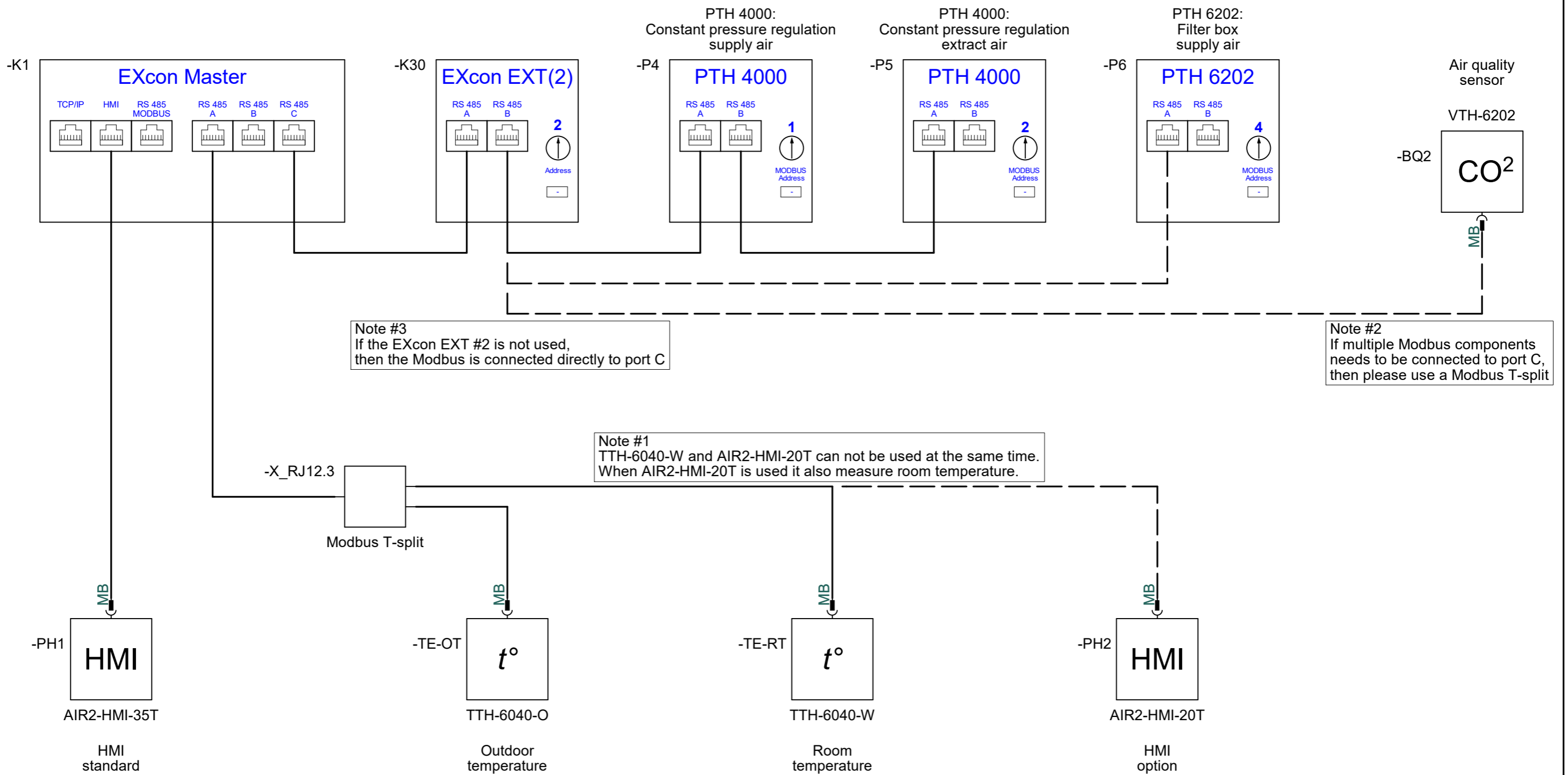

EXHAUSTO

Project:
CX3030 & CX3040

Start date:	24-08-2022	Constructor:	DKTSA	Page:	38
Revision date:	08-11-2023	Approved by:	DKLEG	Previous page:	37
Replaces:	Rev. C	Scale:	1:1	Next page:	40
EC no.:		Format:		Pages in total:	43

Drawing number:
0400102

Revision:
D

Page Title:
Optional accessories MODBUS

Electric heaters

EXHAUSTO	Project: CX3030 & CX3040	Start date: 24-08-2022	Constructor: DKTSA	Page: 40	
		Revision date: 08-11-2023	Approved by: DKLEG	Previous page: 38	
Drawing number: 0400102	Revision: D	Page Title: Electric heaters	Replaces: Rev. C	Scale: 1:1	Next page: 41
			EC no.:	Format:	Pages in total: 43

Component	Function	Position
+A4.1/-E1	Electric heater Step 1	/43.2
+A4.1/-F1	Main fuse	/43.1
+A4.1/-K1	Contactor HE 1	/43.7
+A4.1/-S2	Main switch pre-heater	/43.1
+A4.1/-T1	Fire thermostat 110°C	/43.5
+A4.1/-T2	Overheating thermostat 70°C	/43.5
+A4.1/-T3	Air flow thermostat Open@60°C/Reset@45°C	/43.9
+A4.1/-W1	Main power supply cable	/43.1
+A4.1/-X1	Terminals for Main supply	/43.1
+A4.1/-X3	Terminals for Control signals	/43.5
+A4.1/-X4	Terminals for Air flow OK	/43.9
+A4.2/-E1	Electric heater Step 1	/44.2
+A4.2/-F1	Main fuse	/44.1
+A4.2/-K1	Contactor HE 1	/44.7
+A4.2/-S3	Main switch heater	/44.1
+A4.2/-T1	Fire thermostat 110°C	/44.5
+A4.2/-T2	Overheating thermostat 70°C	/44.5
+A4.2/-T3	Air flow thermostat Open@60°C/Reset@45°C	/44.9
+A4.2/-TC1	Triac HE 1	/44.4
+A4.2/-W1	Main power supply cable	/44.1
+A4.2/-X1	Terminals for Main supply	/44.1
+A4.2/-X3	Terminals for Control signals	/44.4
+A4.2/-X4	Terminals for Air flow OK	/44.9
+A4.3/-E1	Electric heater Step 1	/45.2
+A4.3/-E2	Electric heater Step 2	/45.3
+A4.3/-F1	Main fuse	/45.1
+A4.3/-K1	Contactor HE 1	/45.7
+A4.3/-K2	Contactor HE 2	/45.8
+A4.3/-S2	Main switch pre-heater	/45.1

EXHAUSTO

Project:
CX3030 & CX3040

Start date: 24-08-2022 Constructor: DKTSA Page: 41

Revision date: 08-11-2023 Approved by: DKLEG Previous page: 40

Drawing number: 0400102 Revision: D Page Title: Electric heaters component overview Replaces: Rev. C Scale: 1:1 Next page: 42

EC no.: Format: Pages in total: 43

Component	Function	Position
+A4.3/-T1	Fire thermostat 110°C	/45.5
+A4.3/-T2	Overheating thermostat 70°C	/45.5
+A4.3/-T3	Air flow thermostat Open@60°C/Reset@45°C	/45.9
+A4.3/-W1	Main power supply cable	/45.1
+A4.3/-X1	Terminals for Main supply	/45.1
+A4.3/-X3	Terminals for Control signals	/45.5
+A4.3/-X4	Terminals for Air flow OK	/45.9
+A4.4/-E1	Electric heater Step 1	/46.2
+A4.4/-E2	Electric heater Step 2	/46.3
+A4.4/-F1	Main fuse	/46.1
+A4.4/-K1	Contactor HE 1	/46.7
+A4.4/-K2	Contactor HE 2	/46.8
+A4.4/-S3	Main switch heater	/46.1
+A4.4/-T1	Fire thermostat 110°C	/46.5
+A4.4/-T2	Overheating thermostat 70°C	/46.5
+A4.4/-T3	Air flow thermostat Open@60°C/Reset@45°C	/46.9
+A4.4/-TC1	Triac HE 1	/46.4
+A4.4/-W1	Main power supply cable	/46.1
+A4.4/-X1	Terminals for Main supply	/46.1
+A4.4/-X3	Terminals for Control signals	/46.4
+A4.4/-X4	Terminals for Air flow OK	/46.9

EXHAUSTO	Project:	CX3030 & CX3040	Start date:	24-08-2022	Constructor:	DKTSA	Page:	42				
	Drawing number:	0400102	Revision:	D	Page Title:	Electric heaters component overview	Replaces:	Rev. C	Scale:	1:1	Next page:	43
							EC no.:		Format:		Pages in total:	43

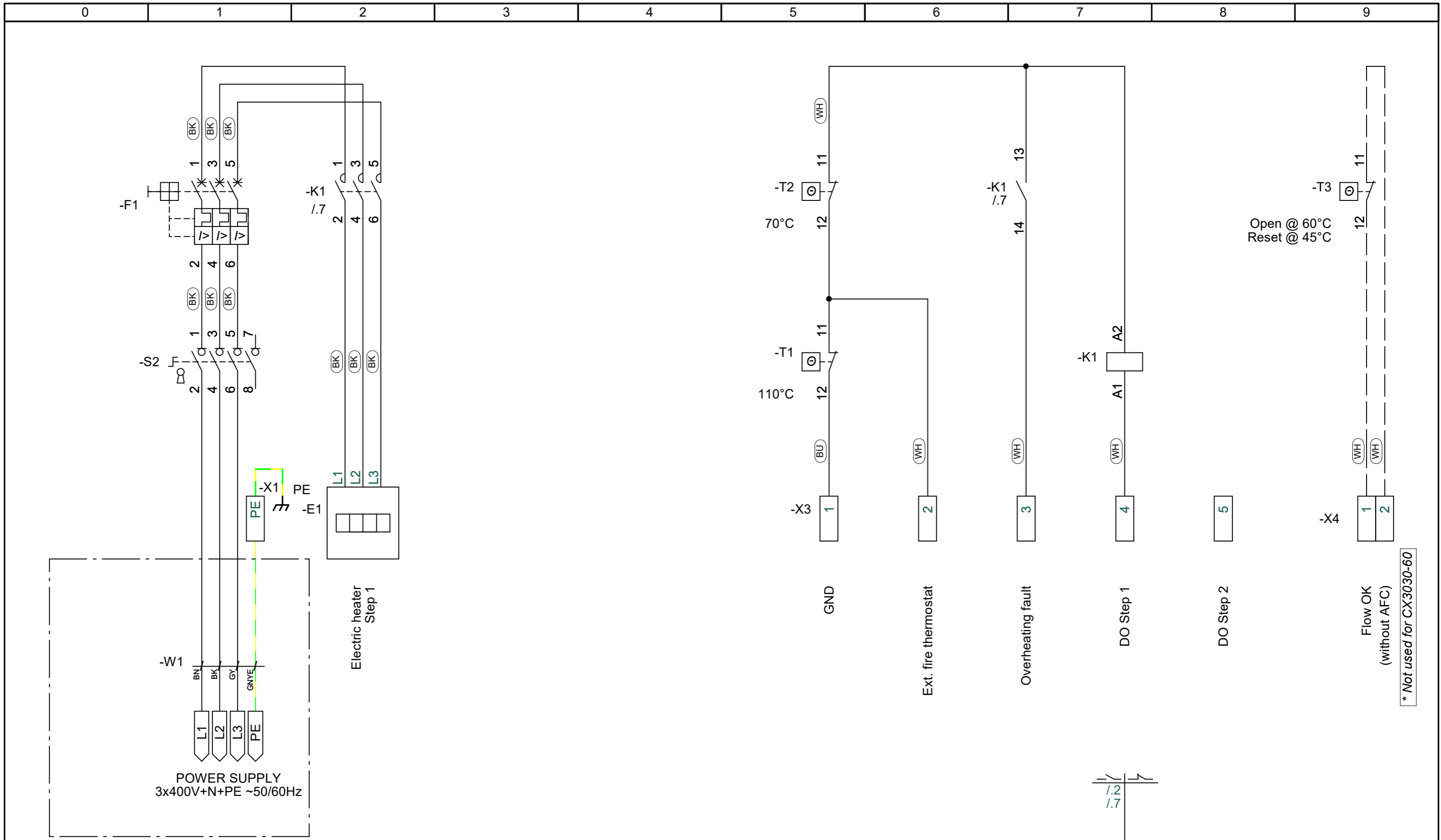

EXHAUSTO

Project:
CX3030 & CX3040

Start date:	24-08-2022	Constructor:	DKTSA	Page:	43
Revision date:	08-11-2023	Approved by:	DKLEG	Previous page:	42
Replaces:	Rev. C	Scale:	1:1	Next page:	44
EC no.:		Format:		Pages in total:	43

Drawing number:
0400102

Revision:
D

Page Title:
Electric pre-heater Step 1

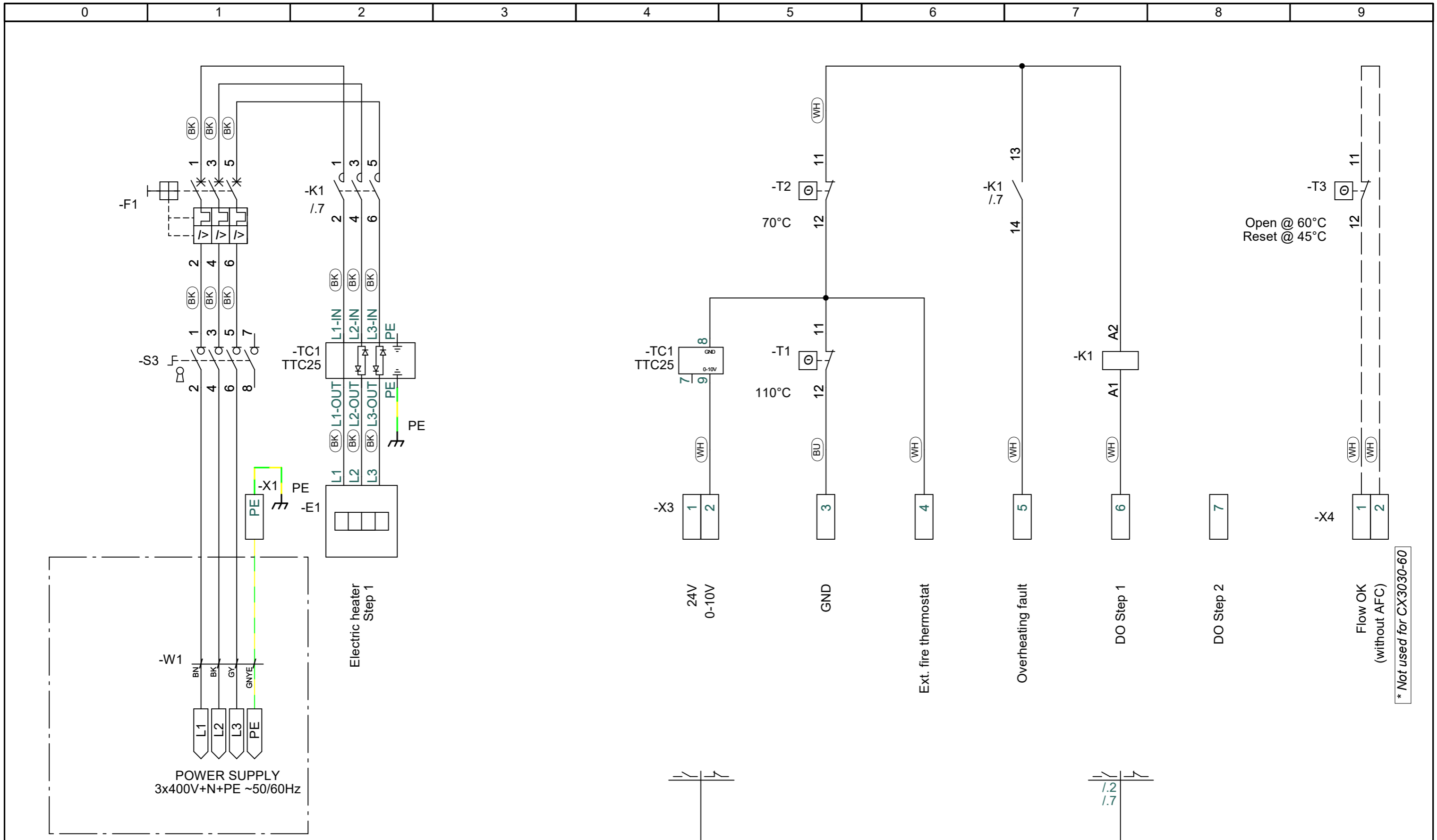

EXHAUSTO

Project:
CX3030 & CX3040

Start date:	24-08-2022	Constructor:	DKTSA	Page:	44
Revision date:	08-11-2023	Approved by:	DKLEG	Previous page:	43
Replaces:	Rev. C	Scale:	1:1	Next page:	45
EC no.:		Format:		Pages in total:	43

Drawing number:
0400102

Revision:
D

Page Title:
Electric heater Step 1

* Not used for CX3030-60

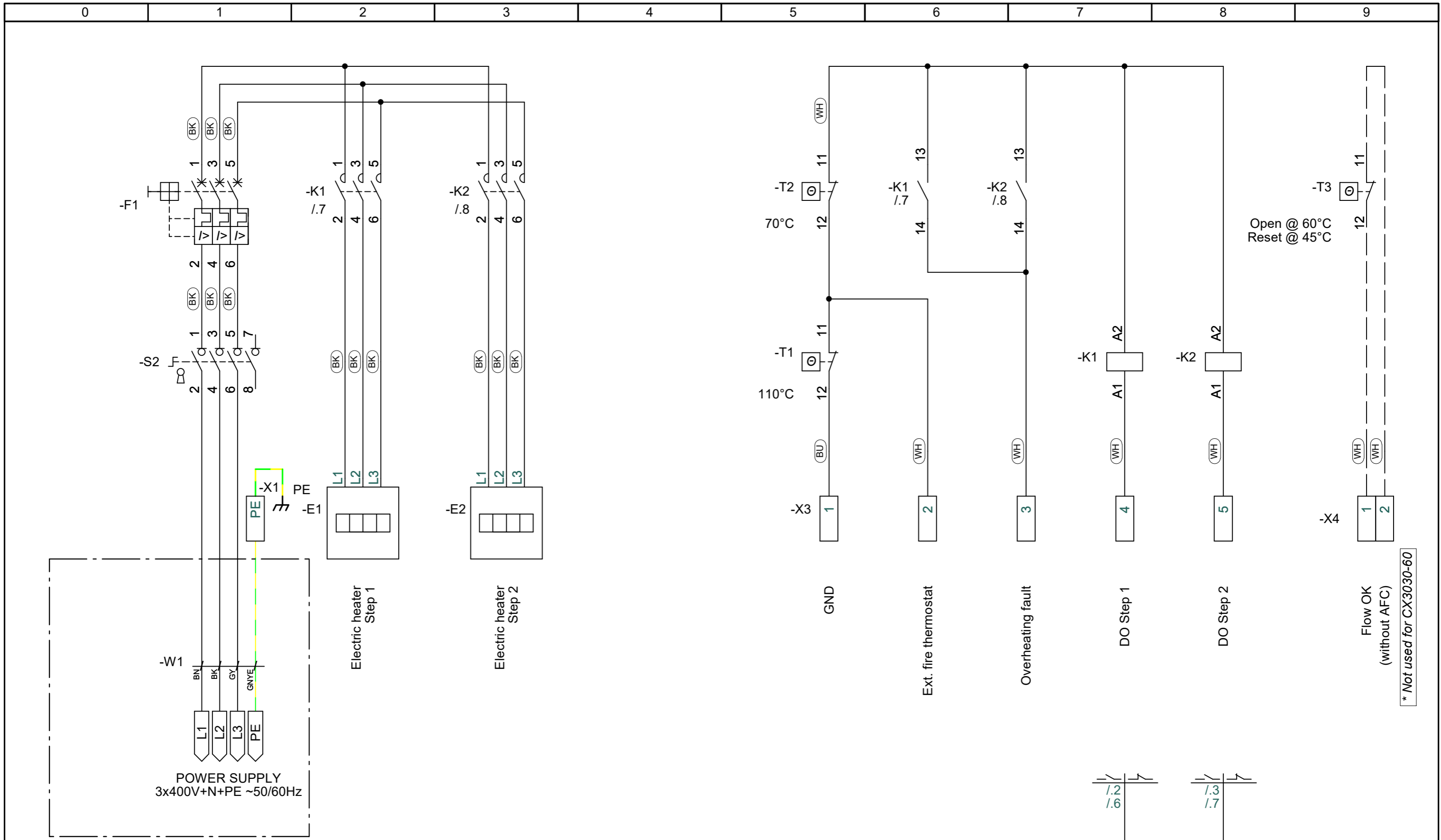

EXHAUSTO

Project:
CX3030 & CX3040

Start date:	24-08-2022	Constructor:	DKTSA	Page:	45
Revision date:	08-11-2023	Approved by:	DKLEG	Previous page:	44
Replaces:	Rev. C	Scale:	1:1	Next page:	46
EC no.:		Format:		Pages in total:	43

Drawing number:
0400102

Revision:
D

Page Title:
Electric pre-heater Step 1 & 2

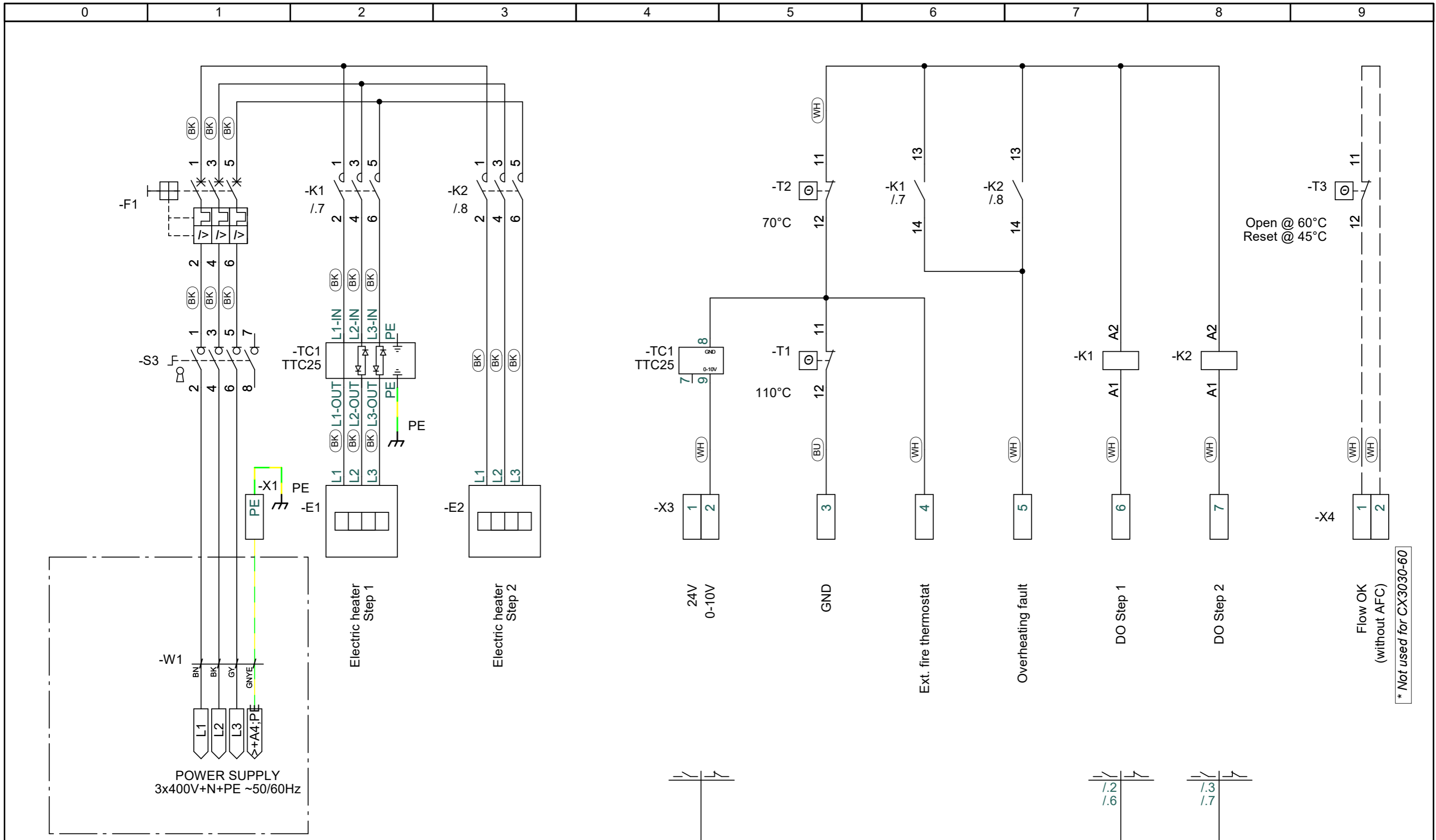

EXHAUSTO	Project: CX3030 & CX3040		Start date: 24-08-2022	Constructor: DKTSA	Page: 46
	Drawing number: 0400102		Revision date: 08-11-2023	Approved by: DKLEG	Previous page: 45
Revision: D	Page Title: Electric heater Step 1 & 2		Replaces: Rev. C	Scale: 1:1	Next page: 47
			EC no.:	Format:	Pages in total: 43

* Not used for CX3030-60

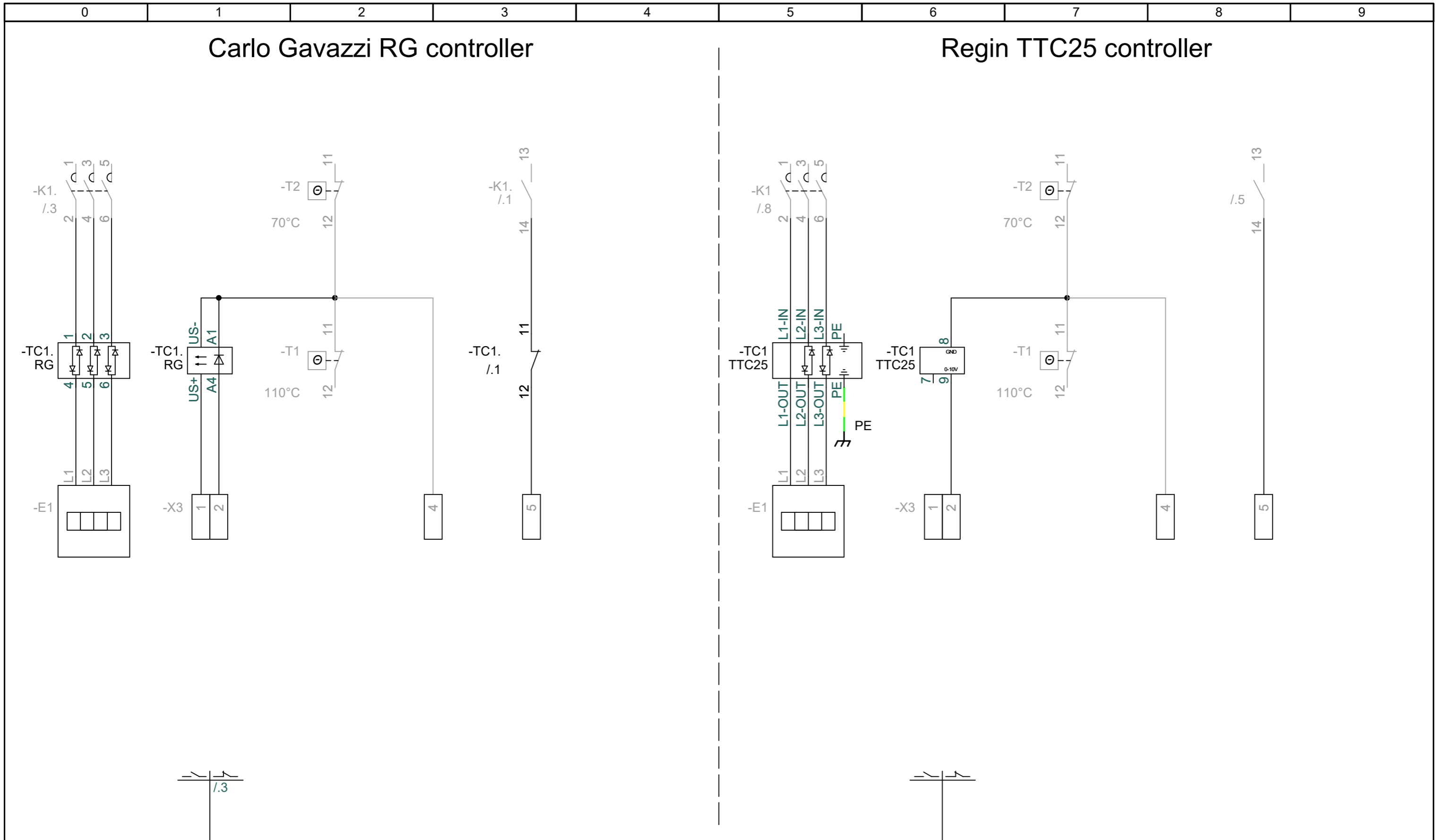

EXHAUSTO

Project:
CX3030 & CX3040

Start date:	24-08-2022	Constructor:	DKTSA	Page:	47
Revision date:	08-11-2023	Approved by:	DKLEG	Previous page:	46
Replaces:	Rev. C	Scale:	1:1	Next page:	
EC no.:		Format:		Pages in total:	43

Drawing number:
0400102

Revision:
D

Page Title:
Carlo Gavazzi RG vs Regin TTC25