





Notice Télécommande Modbus EasyVEC®

Notice de paramétrage **FR**

1. BOUTONS

-  : Retour
-  : Diminuer une valeur et naviguer
-  : Augmenter une valeur et naviguer
-  : Valider

Température ambiante (stockage) : -25°C à +65°C / Humidité Relative de 30% à 100%



2. MONTAGE ET RACCORDEMENT

Le faisceau Modbus se monte sur le connecteur Pin&Past J3 à l'arrière du boîtier en suivant le marquage sur la carte :

- Masse
- Borne A
- Borne B
- Tension +V
- Section des câbles : 4 x 0,35 mm²
ou 4 x 0,5 mm²

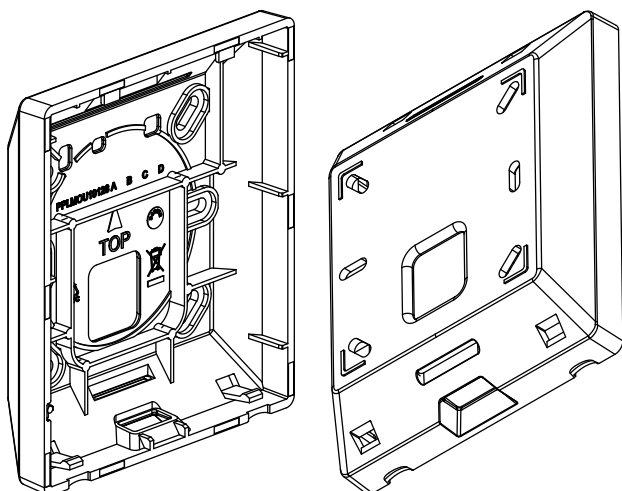



- Démontez la face avant et la face arrière avec un outil (ex : tournevis plat)
- Fixer au mur à l'aide d'une boîte électrique encastrable de Ø 67 mm (entraxe de fixation de 60 mm)
- Passer le câble Modbus par l'ouverture au niveau du connecteur (4 fils entre 0.22 et 0.5 mm²)
- Raccorder électriquement
- Reclipper la face avant

3. ÉTANCHÉITÉ

 L'indice de protection (IPX0) NE permet PAS l'utilisation de cet accessoire dans des conditions extérieures. L'installation doit se faire dans un endroit à l'abri de l'eau.

4. NAVIGATION

 EasyVEC Ultimate Soft version 0.23 ID # 110349991	PARAMÉTRAGES 	PARAMÉTRAGES ▶ Régulation ... Reset	PARAMÉTRAGES ▶ Reset ... Régulation	PARAMÉTRAGES ▶ Régulation ... Reset	
	RÉGLAGES 	RÉGLAGES ▶ Couleur ... Langues	RÉGLAGES ▶ Langues ... N°série		
	LOG ERREUR-S 	LOG ERREUR-S ▶ E31 : C4 détection ✓ pendant 3 s.	LOG ERREUR-S ▶ E55 : Vit. moteur ✓ pendant 3 s.		
CHOIX LANGUES ▶ Français Anglais					





www.aldes.com



Modbus EasyVEC® remote control manual

Installation instructions **EN**

1. BUTTONS

-  : Back
-  : Increase a value and navigate
-  : Decrease a value and navigate
-  : Validate

Ambient temperature (storage): -25 ° C to + 65 ° C / Relative humidity from 30% to 100%



2. INSTALLATION AND CONNECTION

The Modbus harness is mounted on the Pin & Past J3 connector at the rear of the box following the marking on the card:

- Mass
- Terminal A
- Terminal B
- Voltage + V
- Cable section: 4 x 0.35 mm²
or 4 x 0.5 mm²

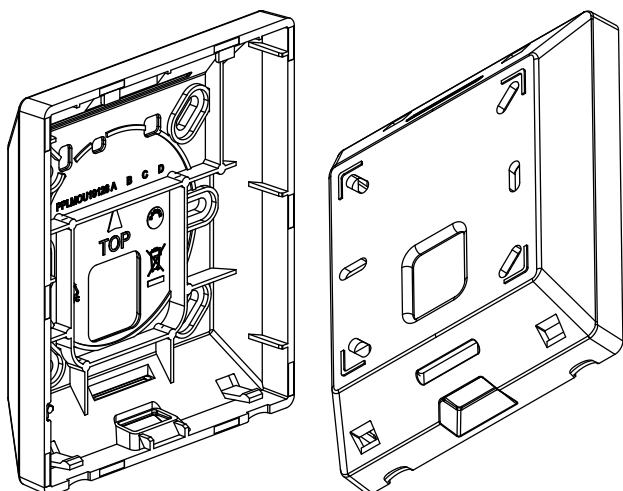

- Remove the front part with a tool (e.g. screwdriver)
- Mount to the wall using an in-wall flush box (67 mm diameter)
- Run the Modbus cable through the cable outlet hole (4 wires between 0.22 and 0.5 mm²)
- Connect the wires to the connector
- Mont the front face back on

3. WATER PROTECTION

-  **IPX0 DO NOT use outside.**
The installation must be done in place protected from water.

4. NAVIGATION

