



## CONSTANT AIRFLOW REGULATORS

---



**CAR3<sup>®</sup>**

PRECISE AIRFLOW

TECHNICAL DOCUMENTATION



## CONTENTS

HOW THE CAR3 WORKS.....	P 6
CAR3 DETAILS.....	P 7
AIRFLOW SETTINGS & PERFORMANCE DATA..	P 8
HOW TO SPECIFY ALDES: CAR3.....	P 10
MODEL CODE EXAMPLE.....	P 10
DIMENSIONS .....	P 10
CONSTANT AIRFLOW REGULATION .....	P 11
ZONE CONTROL .....	P 11
TYPICAL APPLICATIONS .....	P 12
CASE STUDY .....	P 15
CER & CSR ASSEMBLIES.....	P 16
CAR3 SPEC SHEET .....	P 18
CAR3 IOM .....	P 19
MODEL CONFIGURATIONS.....	P 23

# CAR3<sup>®</sup>

CONSTANT AIRFLOW REGULATOR

## New Dual Adjustable CAR3 Constant Airflow Regulator

The new model **CAR3** Constant Airflow Regulator is a modulating orifice that automatically regulates airflows in duct systems to constant levels. The passive control element responds to duct pressure and requires no sensors or controls.

The **CAR3** compensates for changes in duct pressure caused by: use of demand control solutions, thermal stack effect and dust-clogged filters as an example. The **CAR3** provides a low-cost solution to balancing forced-air systems for ventilation, heating, and air conditioning, eliminating the need for on-site balancing. The **CAR3** will regulate airflow in supply, return, or exhaust duct systems. The **CAR3** is designed to complement ALDES register assemblies or can fit inside standard rigid round ducting, as well as fittings such as take-offs, tees, etc. with a double lip gasket around the circumference ensuring a tight, no-leak fit.

The active control element of the **CAR3** is an engineered damper assembly which is calibrated to respond to changes in pressure with no input from an external power source or signal. Operations of the damper assembly regulates the free-areas opening in relation to duct pressure, creating the necessary duct pressure drop to maintain set air flow rates as specified. The **CAR3** is UL 2043 safety classified and labeled for flame and smoke generation.

The **CAR3** airflow regulators control airflow accurately to within 10% of rated flow throughout the target operating pressure ranges; 0.12 to 1.2 in. w.g. (30 to 300 Pa) for low pressure models (CAR3-L), and 0.4 to 2.8 in. w.g. (100 to 650 Pa) for high pressure models (CAR3-H). Airflow set point is selected by turning the adjustment dial on either side (supply or exhaust) of the **CAR3**. The indicator shows the selected CFM. Each diameter of **CAR3** has a unique airflow range for both low- and high-pressure variants, and the setpoint is infinitely adjustable across those ranges. Factory calibration of **CAR3** is available on request.



For more than 35 years, Aldes North America has resolved challenging indoor air quality issues by taking a “systems approach” to ventilation. Aldes North America products are designed for superior airflow control, energy-efficient performance, and a healthy indoor environment.

Aldes North America has specialty ventilation products for single-family homes all the way to towering high-rise buildings. Builders seeking LEED project credits or designers working within challenging constraints will find Aldes North America products are cost effective and suited to their ventilation and indoor air quality needs. When designing your ventilation solution, the experts at Aldes consider many building factors: environmental conditions, building type, occupant demographics, local codes and regulations, as well as budget considerations. This thorough analysis ensures that the product you receive will be a tailored solution for long-lasting performance. We want you to be confident in your choice; from the moment you make the selection to years after installation. Every Aldes product is equal parts innovation and experience. Your business is our pleasure. Your satisfaction is our priority.

# PRECISE AIRFLOW IS THE SIMPLE SOLUTION.

**Quick and easy to install, the CAR3 saves cost, and easy to maintain. Plus, it's made in the USA.**

## EASY TO ADJUST

Adjust from supply or exhaust

## UL 2043

Safety Classified





## HOW THE CAR3 WORKS

Constant airflow is achieved by controlling the free area through the device. At minimum static pressure, the damper is relaxed, providing maximum free area. As the static pressure increases, the damper will rotate, reducing the amount of free area through the regulator resulting in CONSTANT AIRFLOW. This occurs regardless of pressure differences in the range of 0.12 to 1.2 in.w.g. (30 to 300 Pa) for the low-pressure and 0.4 to 2.8 in.w.g. (100 to 650 Pa) for the high-pressure.

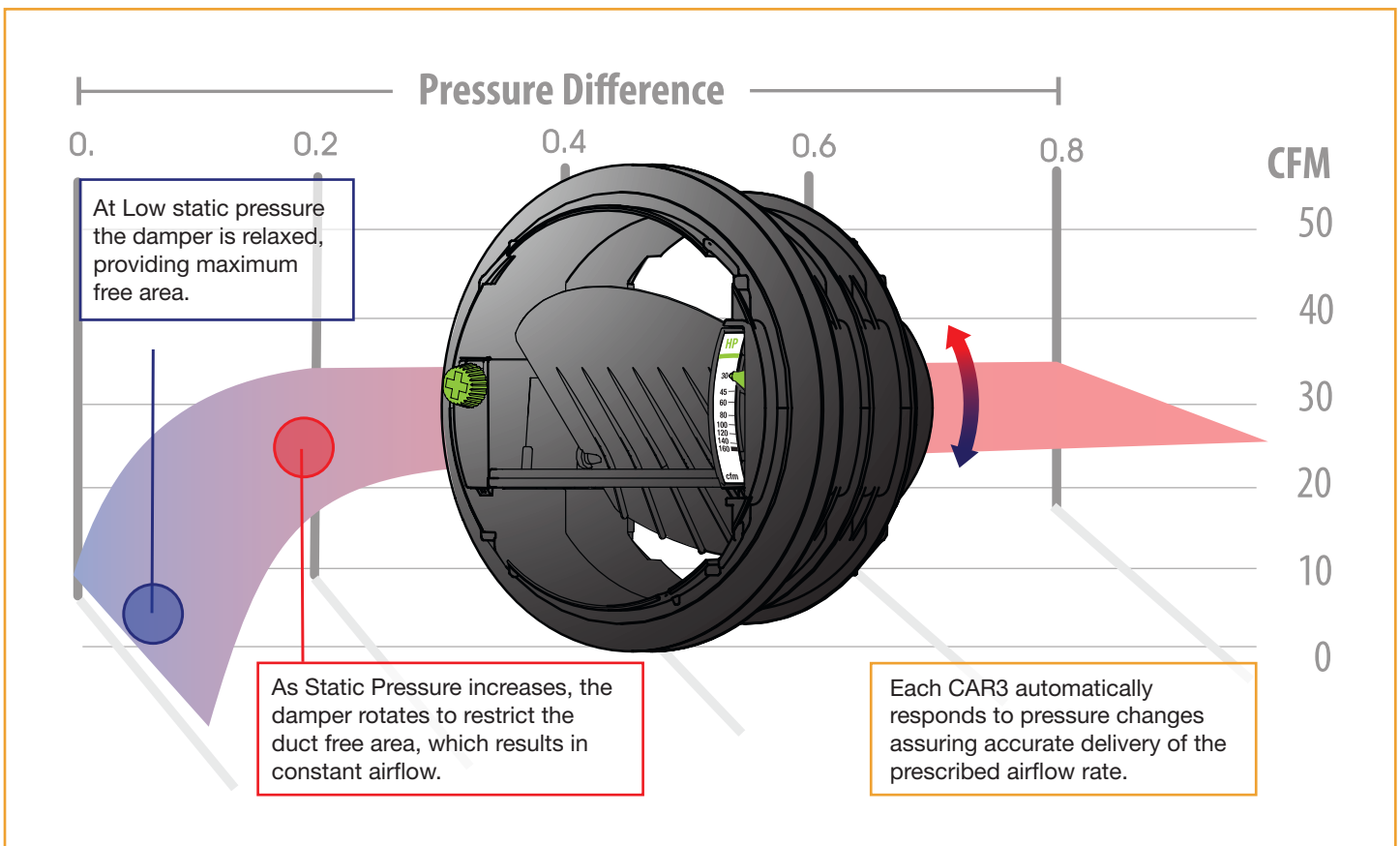

## CAR3 DETAILS OF THE AIRFLOW REGULATOR MODEL

Made in  
**USA**

WARRANTY  
**7 YEARS**



ACTIVE  
 U.S  
 PATENT

### Adjustment dial

Dual-side airflow adjustment dial and CFM indicator allows you to set or change the airflow quickly, in supply or exhaust applications, without removing the CAR3 from the duct.

- Easy to handle with or without tool.

### Gasket

Double lip gasket around the circumference ensures a tight, no-leak fit.

### Airflow

- Infinitely variable between the range.
- Value indicator visible on both sides of the product.

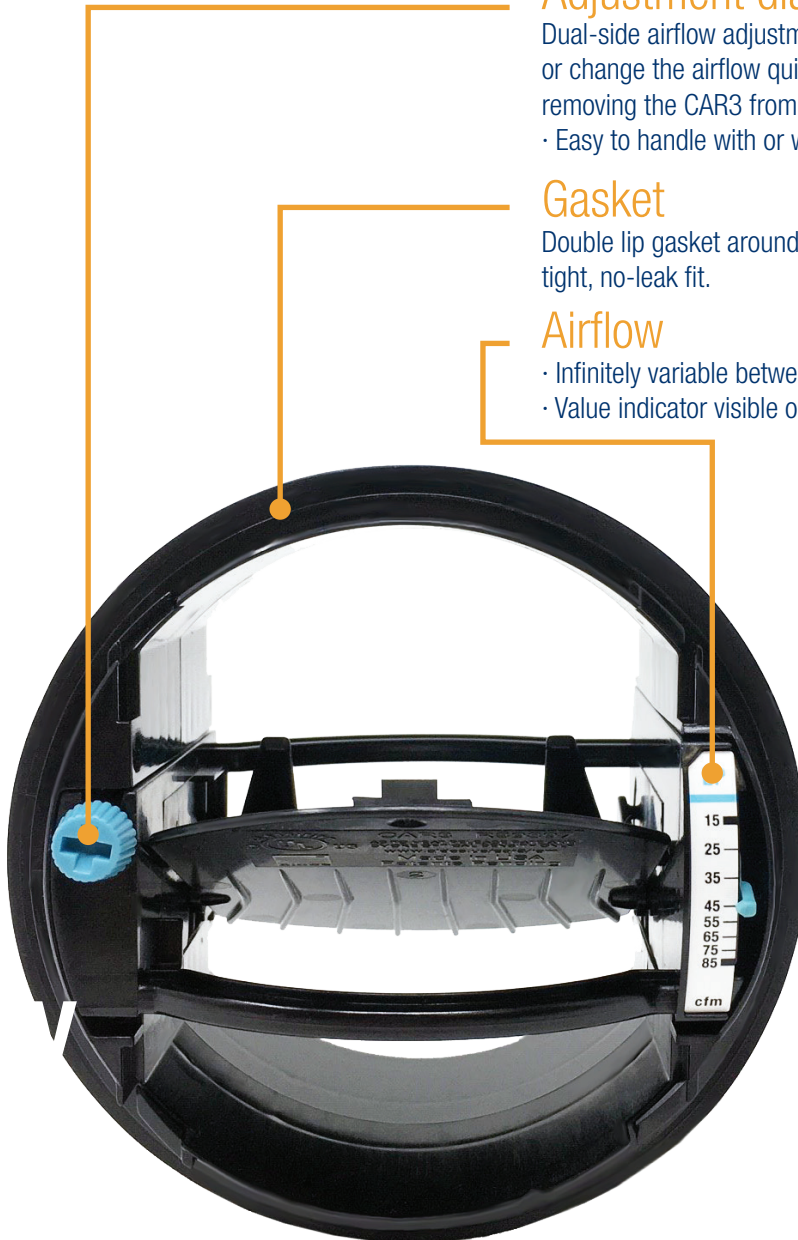

**BLUE COLOR = LOW-PRESSURE**  
 LOW: 0.12 to 1.2 in. w.g. (30 to 300 Pa)



**GREEN COLOR = HIGH-PRESSURE**  
 HIGH: 0.4 to 2.8 in. w.g. (100 to 650 Pa)

### AIRFLOW SETTINGS & PERFORMANCE DATA

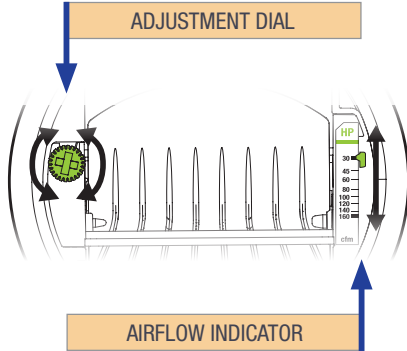

Airflow rate can be set or adjusted by rotating the dial from either side. The airflow indicator will move to show the selected CFM. The airflow label has multiple defined setpoints, but the unique adjustment mechanism of the CAR3 allows for infinite adjustability between the minimum and maximum limits.

Performance charts found in the specifications sheet reflect this data, with the available range. The CAR3 will maintain the airflow accurately to within +/- 10% of the indicated lines below for each marked setpoint (performance tested thru NF E51-776-1 and NF E51-776-2 standards). At the higher airflow rates, the minimum pressure required to achieve the selected airflow may exceed 0.12 in.w.g.

#### CAR3 4" DIAMETER (100 mm)

Low Pressure

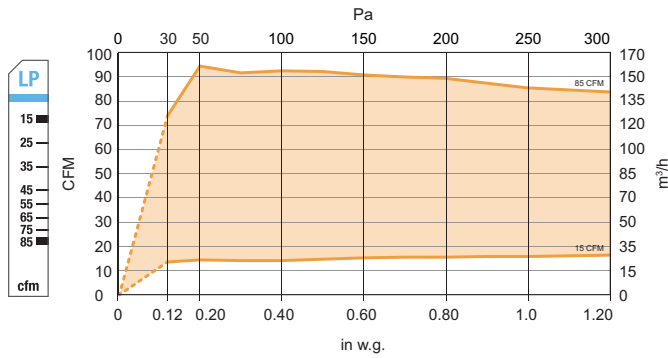

High Pressure

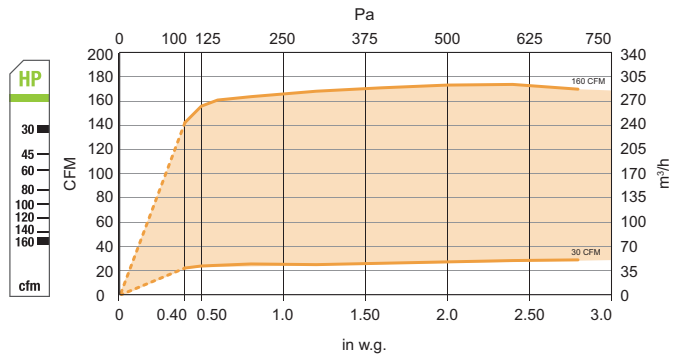

#### CAR3 5" DIAMETER (125 mm)

Low Pressure

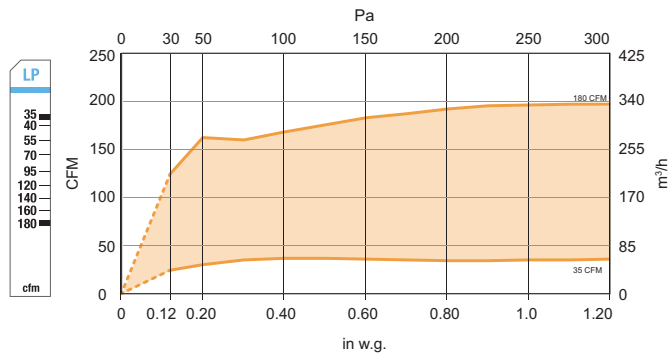

High Pressure

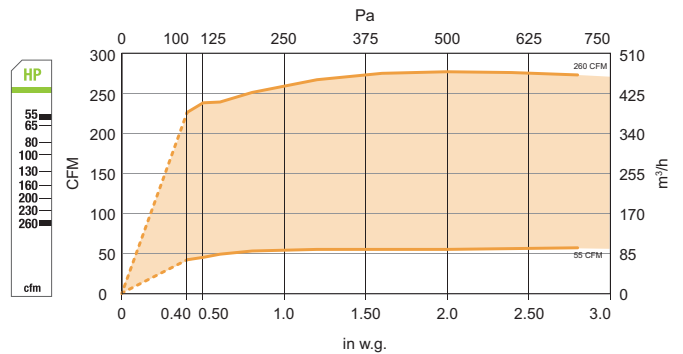

**CAR3 6" DIAMETER (150 mm)**

Low Pressure

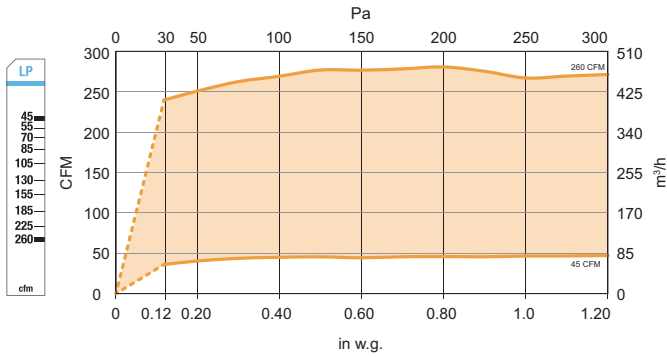

High Pressure

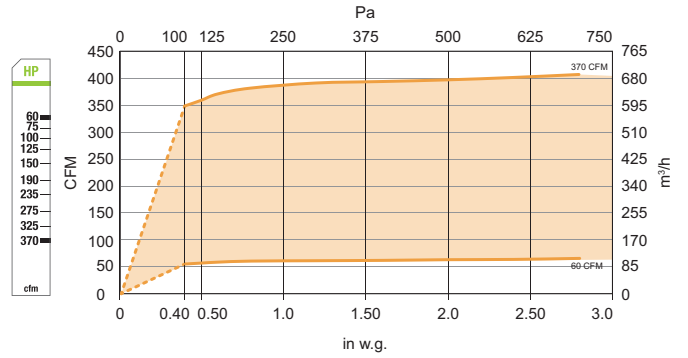

**CAR3 8" DIAMETER (200 mm)**

Low Pressure

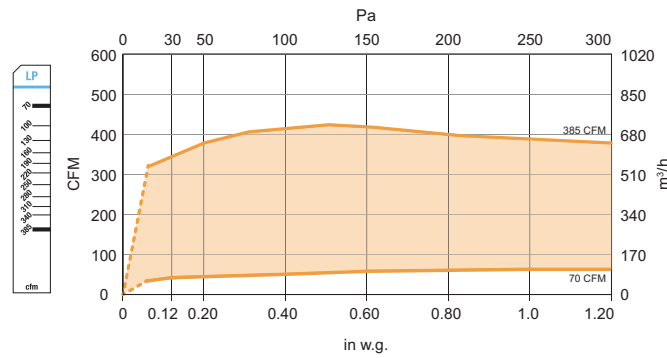

High Pressure

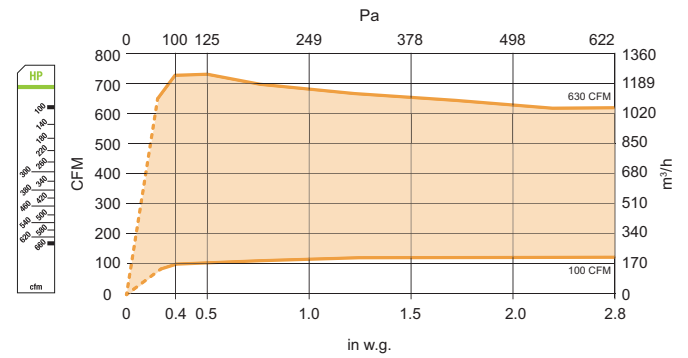

**CAR3 10" DIAMETER (250 mm)**

Low Pressure

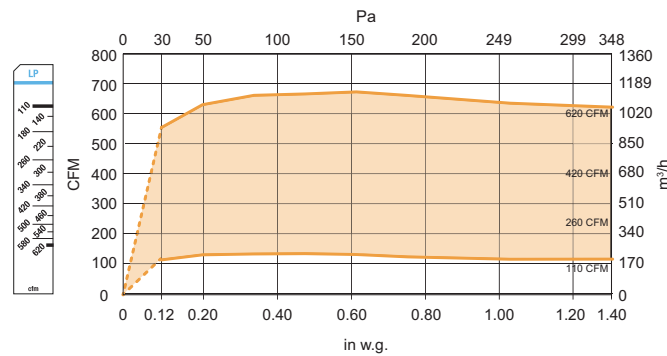

High Pressure

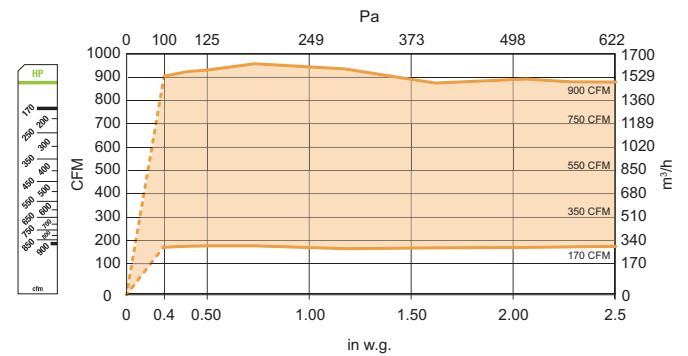

Airflow measurements taken at 68°F (20°C) at 1 atmosphere pressure.

### HOW TO SPECIFY ALDES: CAR3

- Step 1:** Reference the model code below and performance details within this specifications sheet to select the appropriate CAR3.
- Step 2:** Determine the required PRESSURE RANGE for the CAR3 based on the anticipated external static pressure of the system at the installed CAR3 location.
- Each diameter has a unique range for both low- and high-pressure variants. The CAR3-L (low-pressure) is designed for systems with pressures between 0.12 and 1.2 in. w.g. (30 to 300 Pa), and CAR3-H (high-pressure) between 0.4 and 2.8 in. w.g. (100 to 650 Pa). Factory calibration of the CAR3 is available on request.
- Step 3:** Select the desired AIRFLOW RANGE. 4, 5, 6, 8 or 10. Each regulator is infinitely adjustable within their range.
- Step 4:** Select the ROUND DUCT SIZE. This number cannot be less than the AIRFLOW RANGE: i.e. 5 requires a selection of at least 5 inch round duct, and can be at most 6 inches, but can not be 4 inches.

### MODEL CODE EXAMPLE

#### CAR3-L4-R4

##### PARENT MODEL

Constant Airflow Regulator

##### PRESSURE RANGE

L: Low-Pressure (0.12-1.2 in. w.g.)  
H: High-Pressure (0.4-2.8 in. w.g.)

##### AIRFLOW RANGE

Low-Pressure

- 4: 15-85 CFM (25-144 m<sup>3</sup>/h)
- 5: 35-180 CFM (59-306 m<sup>3</sup>/h)
- 6: 45-260 CFM (76-442 m<sup>3</sup>/h)
- 8: 70-385 CFM (119-655 m<sup>3</sup>/h)
- 10: 110-620 CFM (187-1053 m<sup>3</sup>/h)

High-Pressure

- 4: 30-160 CFM (51-272 m<sup>3</sup>/h)
- 5: 55-260 CFM (93-442 m<sup>3</sup>/h)
- 6: 60-370 CFM (102-629 m<sup>3</sup>/h)
- 8: 130-630 CFM (220-1070 m<sup>3</sup>/h)
- 10: 170-900 CFM (289-1529 m<sup>3</sup>/h)

##### ROUND DUCT SIZE

- R4: 4 inch
- R5: 5 inch
- R6: 6 inch
- R8: 8 inch
- R10: 10 inch



CAR3 with Duct Size Adapters.  
Color indicate ring sizes.

### DIMENSIONS

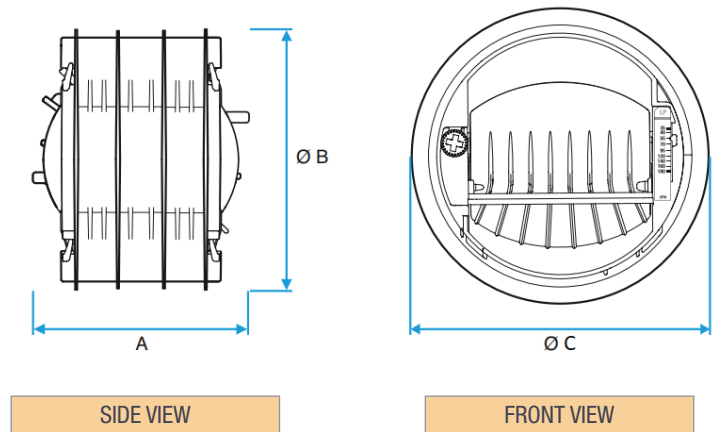

Duct Size	A	ØB	ØC
4" (100 mm)	3" (78 mm)	3.8" (97 mm)	4.1" (104 mm)
5" (125 mm)	3.8" (97 mm)	4.8" (121 mm)	5.2" (132 mm)
6" (150 mm)	4.6" (118 mm)	5.8" (148 mm)	6.1" (155 mm)
8" (200 mm)	6.7" (170 mm)	7.7" (196 mm)	8.2" (208 mm)
10" (250 mm)	8.3" (211 mm)	9.6" (244 mm)	10.2" (259 mm)

When necessary, CAR3 will be provided with duct size adapters to increase their size for larger round duct applications. Each ring increases the CAR3 diameter by one inch, and multiple rings can be used with a maximum size of 6 inches.

**CONSTANT AIRFLOW REGULATION**

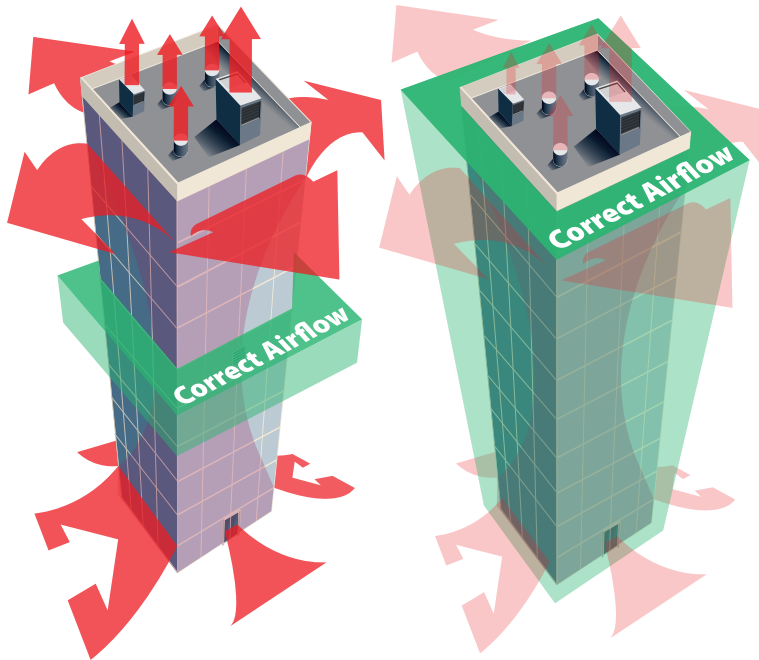

Before CAR3 Installation

After CAR3 Installation

Supply and return/exhaust airflow for each area is automatically balanced by installing the CAR3 in the branch ducts or terminal device locations. CAR3 are commonly used in heat and energy recovery systems to ensure maximum efficiency.

**Stack effect** occurs when air is heated and rises in the shaft forcing more air in the lower floors and out the top floors. This results in pressure variation to vertically ducted central ventilation systems, causing over-ventilation at some levels that wastes energy, and under-ventilation at other levels which prevents proper contaminant removal. These pressure imbalances can also cause cross-contamination or force unwanted air from one compartment to the next. Cross-contamination is often the cause of many poor indoor air quality problems.

Installing a CAR3 at each grille or diffuser location eliminates stack effect on the ventilation system.

**COST SAVING**

Good IAQ on every floor.

**ZONE CONTROL**



Airflow controlled by CAR3. ZRT shown.

Motorized dampered zoning systems can be plagued by wide variations in duct pressure resulting in little to no control over airflow delivery rates. The pressure-independent CAR3 keeps airflow rates constant on demand. For added flexibility in systems requiring zoning, ALDES Zone Register Terminals provide simple demand control solutions for a wide variety of applications, from in-suite hotel ventilation solutions, to multi-family bathroom exhaust and makeup air, and commercial demand control requirements to meet code.

## CAR3 TYPICAL APPLICATIONS

- Automatic balancing damper.
- New construction or retrofit.
- Supply and exhaust air in offices.
- Balancing exhaust/return and supply airflows in high-rise building duct risers, common areas, and living spaces.
- Regulation of make-up air.
- Bathroom exhaust in nursing homes, hotels, motels, dormitories, apartment buildings, offices, etc.
- Clean room air supply balancing for ceiling filter modules. Maintains constant airflow even as filter resistance increases.
- Balancing supply airflow from packaged roof-top A/C units.
- Balancing supply and exhaust/return of heat recovery ventilation systems.
- Regulating outdoor air injection from central supply fan into individual room fan coil units or heat pumps.





## CASE STUDY

In October 2008, the NAHB Research Center published a case study that showed conclusively how installing ALDES Constant Airflow Regulators improves airflow balance in multi-story buildings with central exhaust ventilation systems. This improvement provides many benefits, among them: “consistent airflow to... lower stories,” “[preventing] overventilation to upper units,” “without seasonal maintenance or electrical supply to the CAR regulator. Most importantly, the study finds that the CAR provides “considerable operating cost savings,” with “over 27% energy savings”.

Airflow data for each floor from Partnership for Advancing Technology in Housing’s Final Report on the Evaluation of Constant Airflow Regulators (CAR) in Multi-Family, Multi-Story Central Ventilation Systems, (October 2008). Provided by the NAHB Research Center.

### BEFORE (RED CHART)

Bathrooms in the building were over-ventilated by ~150% in over 60% of all apartments. This represents a serious waster of energy in addition to inflated operations costs. Bathrooms were under ventilated in just over 30% of all apartments, posing a serious Indoor Air Quality issue. Only 10% of the units were being properly ventilated per code.

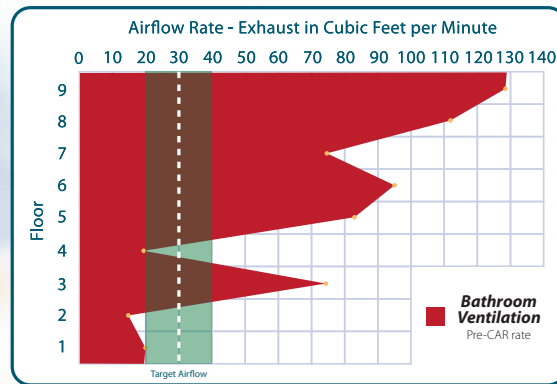

### AFTER (BLUE CHART)

When the NAHB Research Center visited the site to follow up, they calculated the installation of ALDES CAR generated an “energy savings of over 27%”.

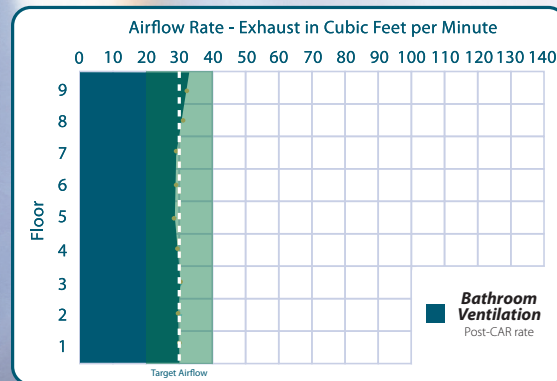

### CONSTANT EXHAUST REGISTER (CER) & CONSTANT SUPPLY REGISTER (CSR) ASSEMBLIES



CER3-S

Square or Rectangle Duct

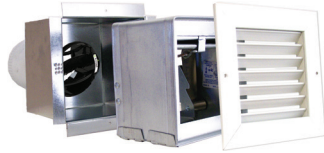

CER3-S-F

Fire Damper Included

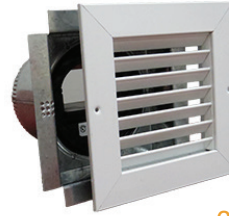

CER3-R

Round Duct



CSR3-S

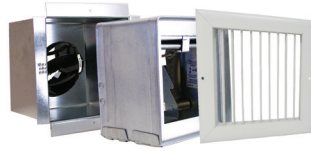

CSR3-S-F



CSR3-R

### APPLICATIONS

- Automatic balancing grille assembly for square, rectangle, round duct.
- Balance exhaust/return or supply duct in high-rise buildings.
- Balance exhaust/return or supply to common areas & living spaces.

### CONSTANT EXHAUST BOX (CEB) & CONSTANT SUPPLY BOX (CSB) ASSEMBLIES

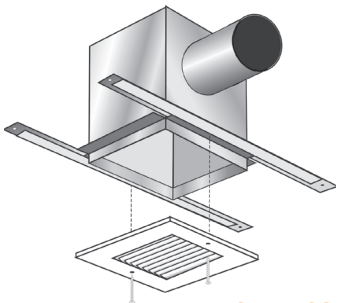

CEB3-CS  
CSB3-CS  
CEB3-CS-F  
CSB3-CS-F

Ceiling Side  
(with optional ceiling radiation damper)

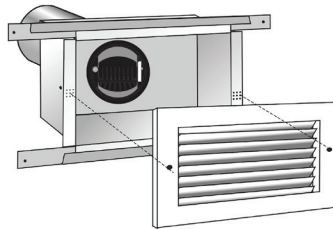

CEB3-WB  
CSB3-WB

Wall Back

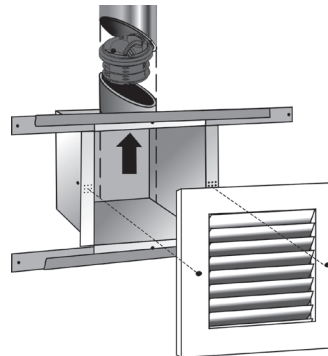

CEB3-WS  
CSB3-WS

Wall Side

### APPLICATIONS

- Automatic balancing register box assembly for ceiling or wall installation.
- Balance exhaust/return or supply air in high-rise buildings.
- Ideal for hotels, dorms, and assisted living facilities

# CAR3

**Product Specifications &  
Technical Data  
and Installation  
Operation Maintenance**

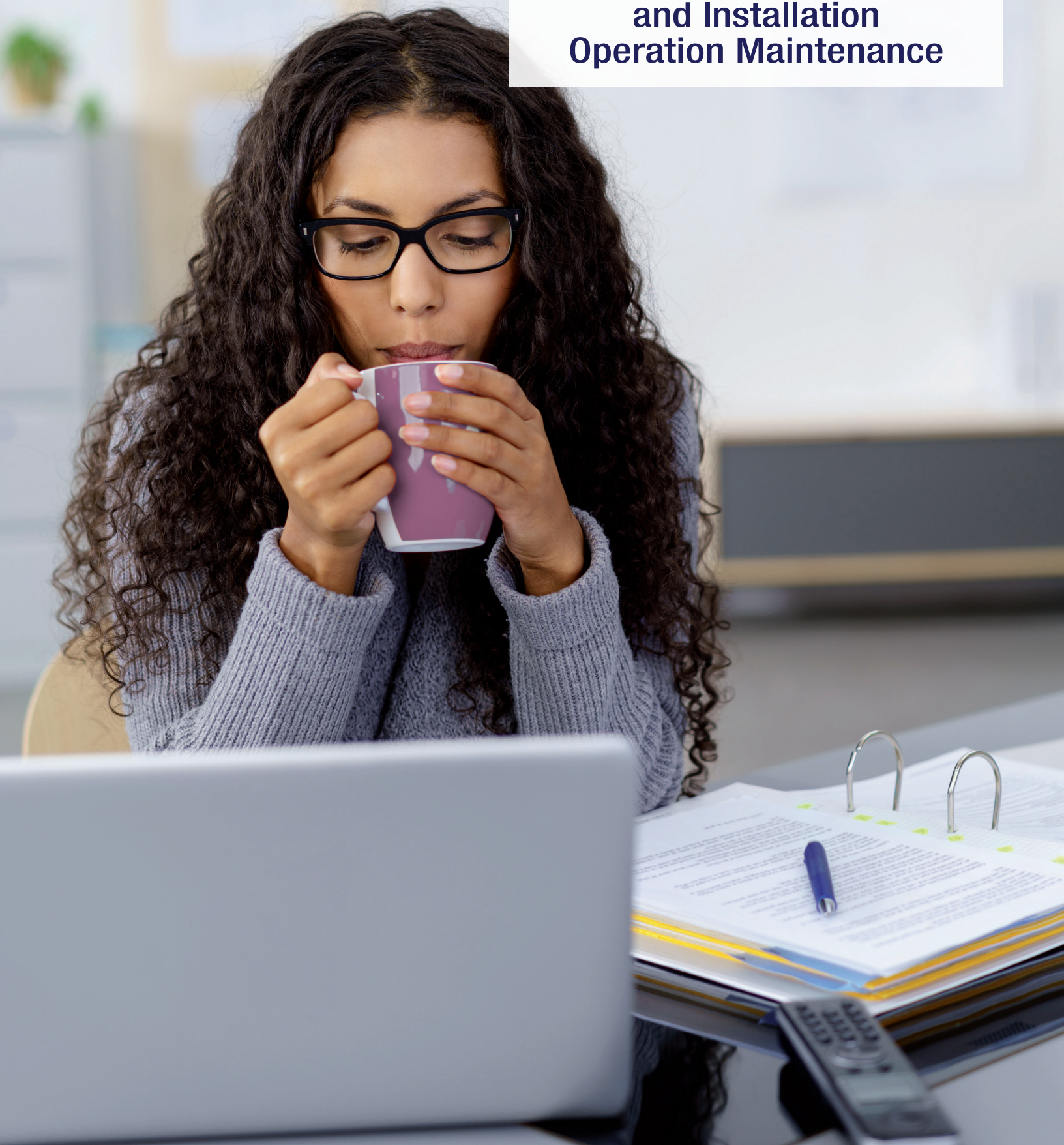

### MODEL CONFIGURATIONS

Model	Use		Duct Type		Fire Damper
	Exhaust	Supply	Round	Square/ Rectangular	
CAR3	√	√	√		
CAR3-S	√	√		√	
CER3-S	√			√	
CSR3-S		√		√	
CER3-S-F	√			√	√
CSR3-S-F		√		√	√
CER3-R	√		√		
CSR3-R		√	√		
<b>REGISTER BOXES</b>					
CEB3-WS	√		√		
CSB3-WS		√	√		
CEB3-WB	√		√		
CSB3-WB		√	√		
CEB3-CS	√		√		
CSB3-CS		√	√		
CEB3-CS-F	√		√		√
CSB3-CS-F		√	√		√

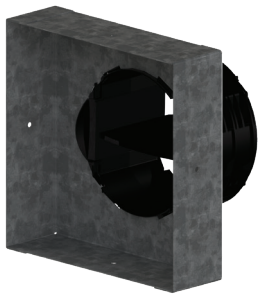

CAR3-S



CER3-S



ZRT®



For more information, contact your  
Aldes sales advisor, visit [aldes-na.com](http://aldes-na.com),  
or find us on



Aldes North America  
USA 800.255.7749 CAN 800.262.0916

100325 - CAR3 Brochure  
©2025 American ALDES Ventilation Corporation and ALDES Canada. All Rights Reserved.  
Reproduction or distribution, in whole or in part, of this document, in any form or by any means, without the express written consent of American ALDES Ventilation Corporation and/or ALDES Canada, is strictly prohibited.  
The information contained within this document is subject to change without prior written notice.

